

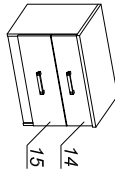

**ORLANDO**  
**STOLIK NOCNY**

Instrukcja montażu  
Assembly instructions



No	Stc	L	W	T
1	1	418	325	16
2	1	468	60	16
3	1	468	325	16
4	1	418	325	16
5	1	500	350	22
6	1	496	378	3
7	1	310	160	16
8	1	410	142	16
9	1	310	160	16
10	2	424	317	3
11	1	310	110	16
12	1	410	90	16
13	1	310	110	16
14	1	496	150	16
15	1	496	200	16

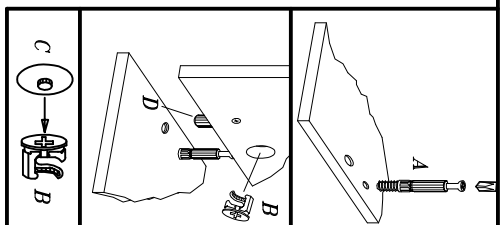
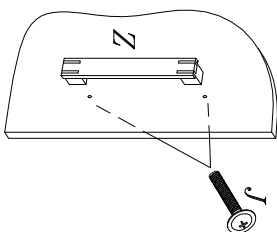
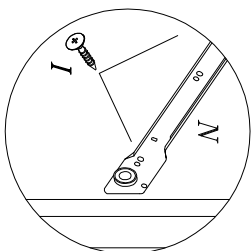
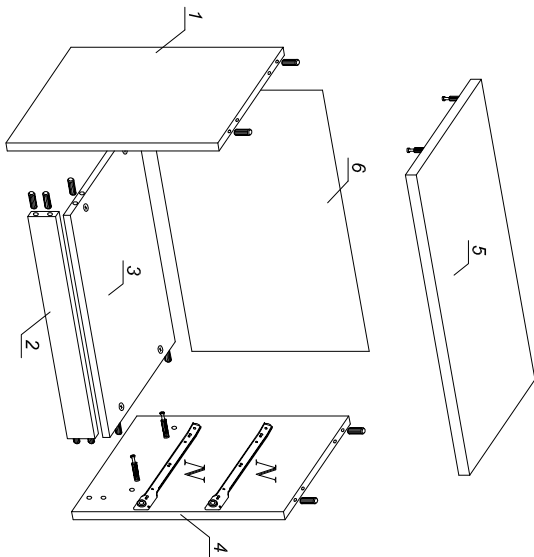
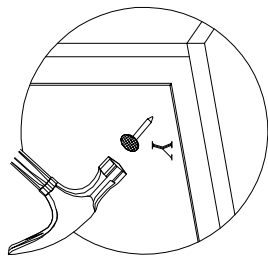
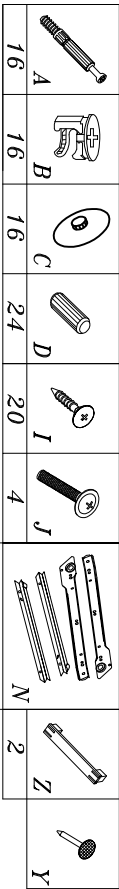

**UWAGA! WAŻNE!**  
**KOŁKI WBIJAĆ JAK NA PONIŻSZYM**  
**RYŚ. W KRAWĘDZĀ ELEMENTU!**

**UWAGA!**  
**ATTENTION:**

