

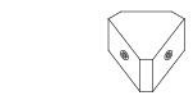

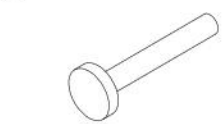

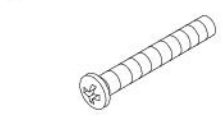
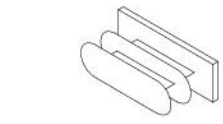

- (A)  x3
- (B)  x1
- (C)  x1
- (D)  x3
- (E)  x3
- (F)  x3
- (G)  x6
- (H)  x3