







A		2
B		4
C	 $\phi 20\text{mm}$	4
D	 M6*15mm	32
E	 4mm	1



 max. 20 kg

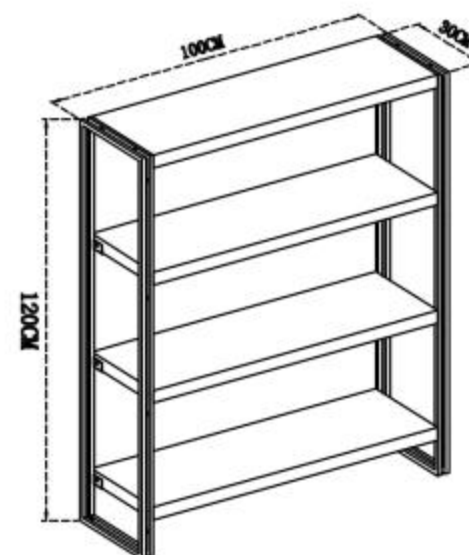