

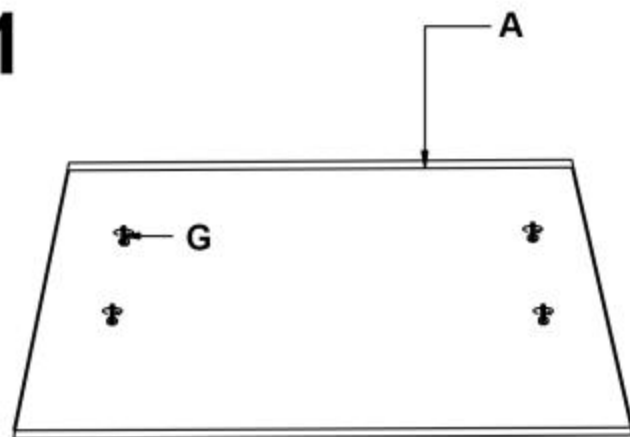

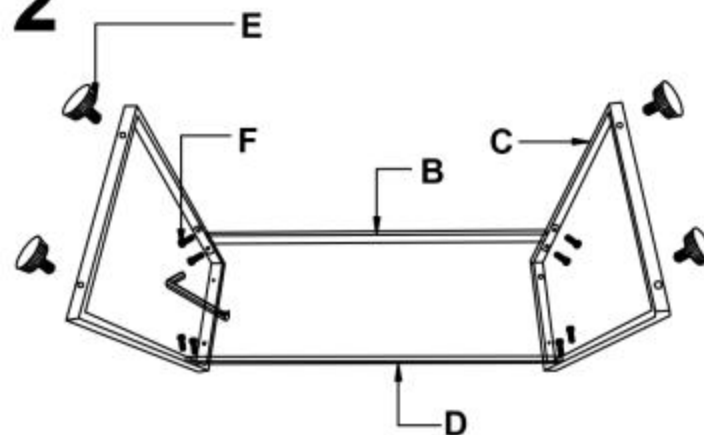

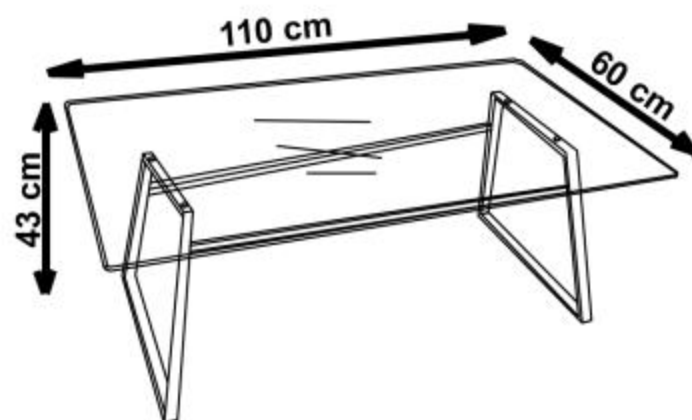

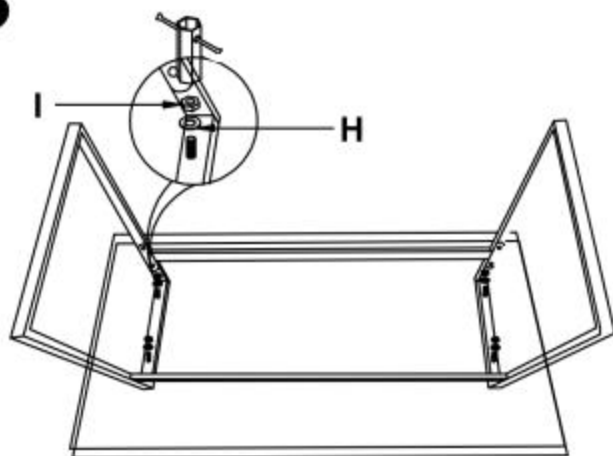



1**2****3**
 max. 20 kg

A		1
B		1
C		2
D		1
E		4
F		8
G		4
H		4
I		4