

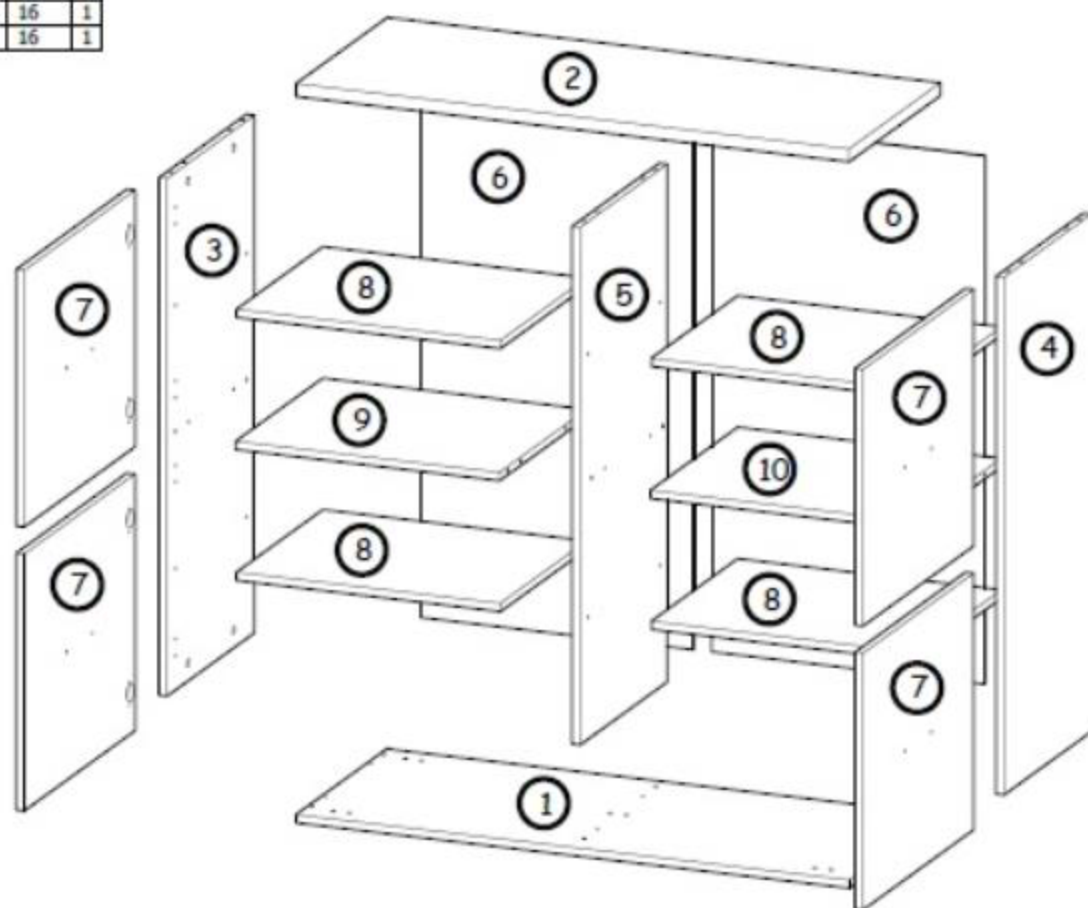

















Nr	Xmm	Ymm	Zmm	x
1	1100	450	16	1
2	1100	450	25	1
3	998	432	16	1
4	998	432	16	1
5	998	429	16	1
6	1018	543	2,5	2
7	545	495	16	4
8	525	425	16	4
9	525	429	16	1
10	525	429	16	1



B1 20x ø8x35 	K5 20x 34mm 	K1 20x ø15x12 	I20 20x ø4/ø17 	U10 1x 	E43 4x 160mm 
N15 8x M4x25 	D3 8x PZ35PR 	C3 8x Z35PR 	G34 16x 3,5x16 	W4 69x 	S2 11x ø20x2 
P29 4x H150m 	A1 10x ø7x50 	I12 10x ø4/ø11 	P28 1x H150m 	W2 1x 4mm 	F2 16x ø5 

III

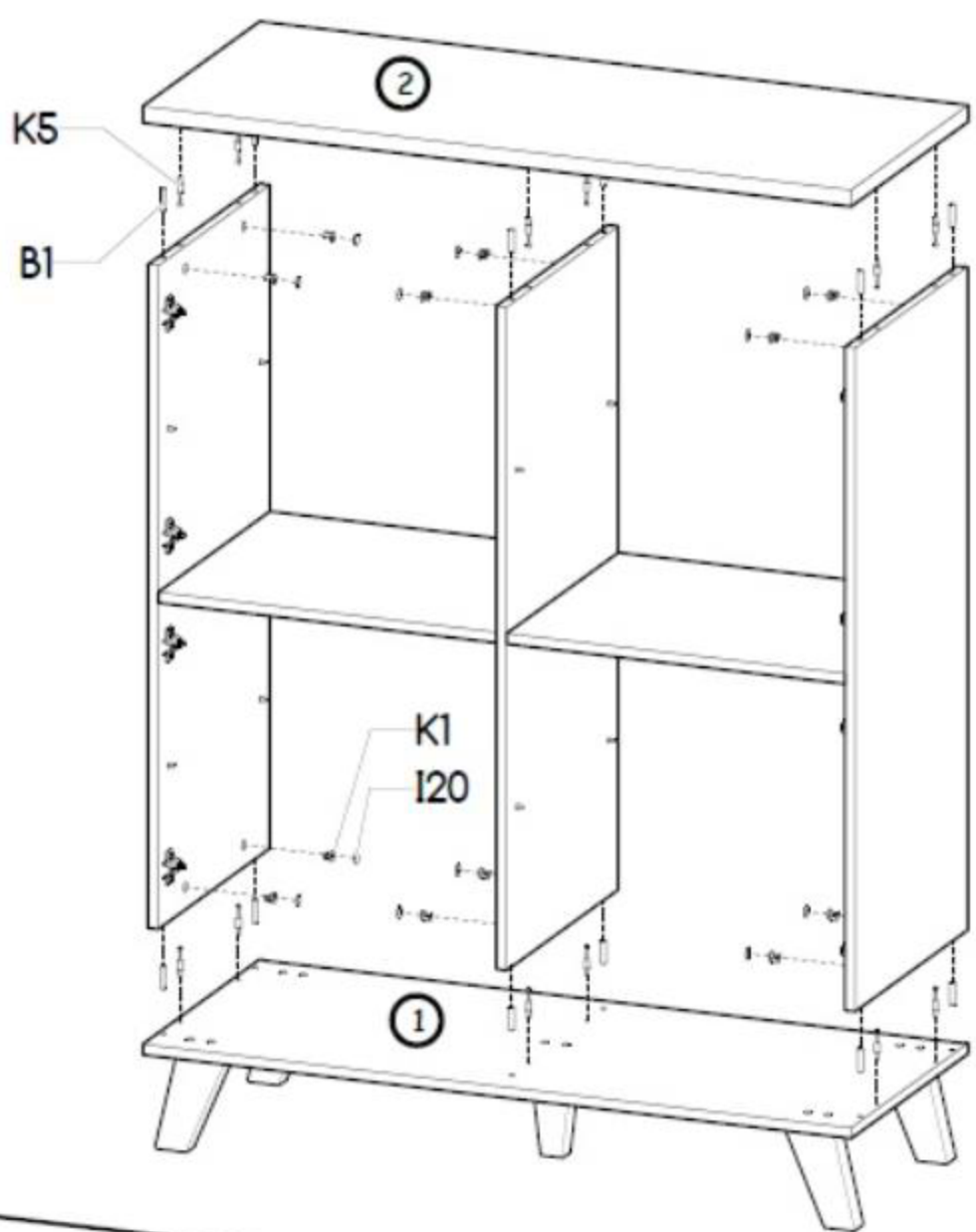

IV

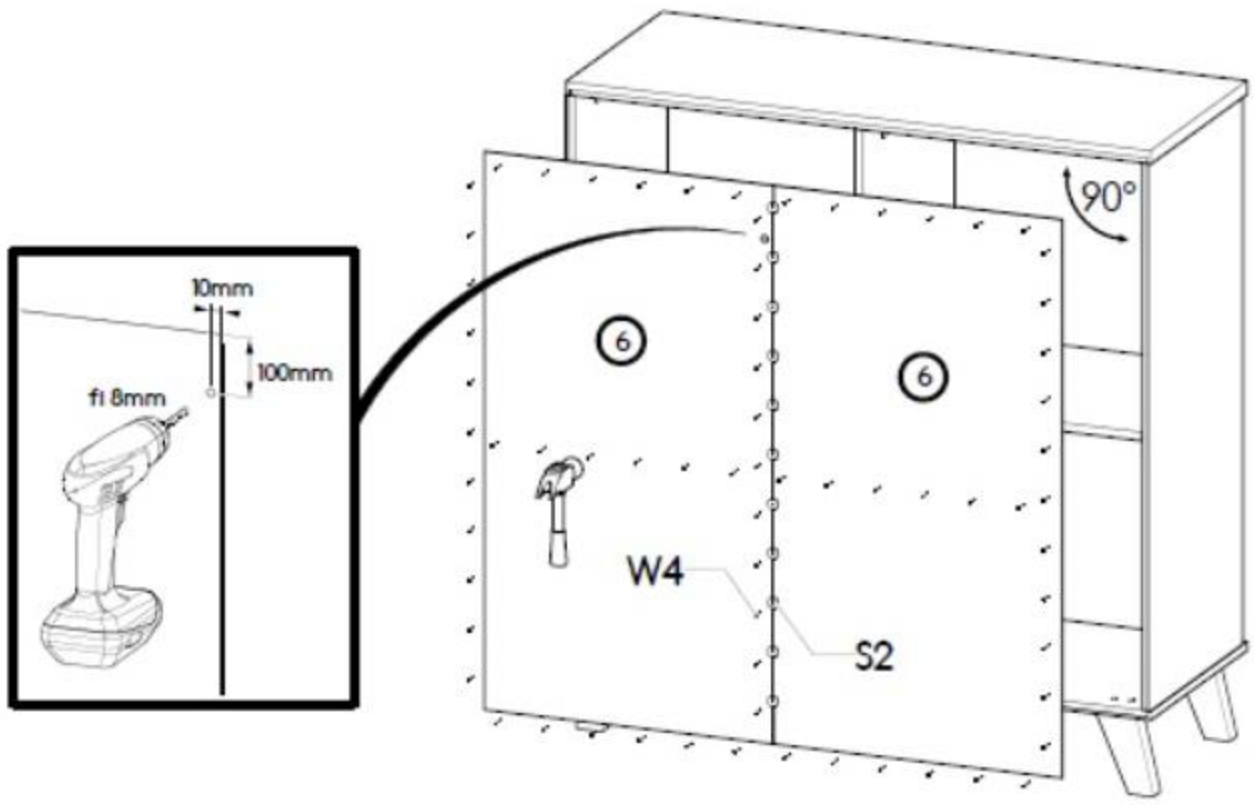

V

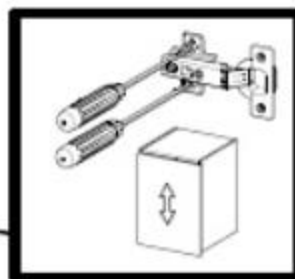
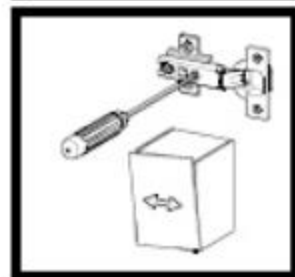
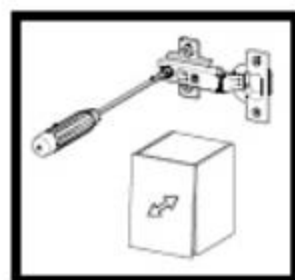
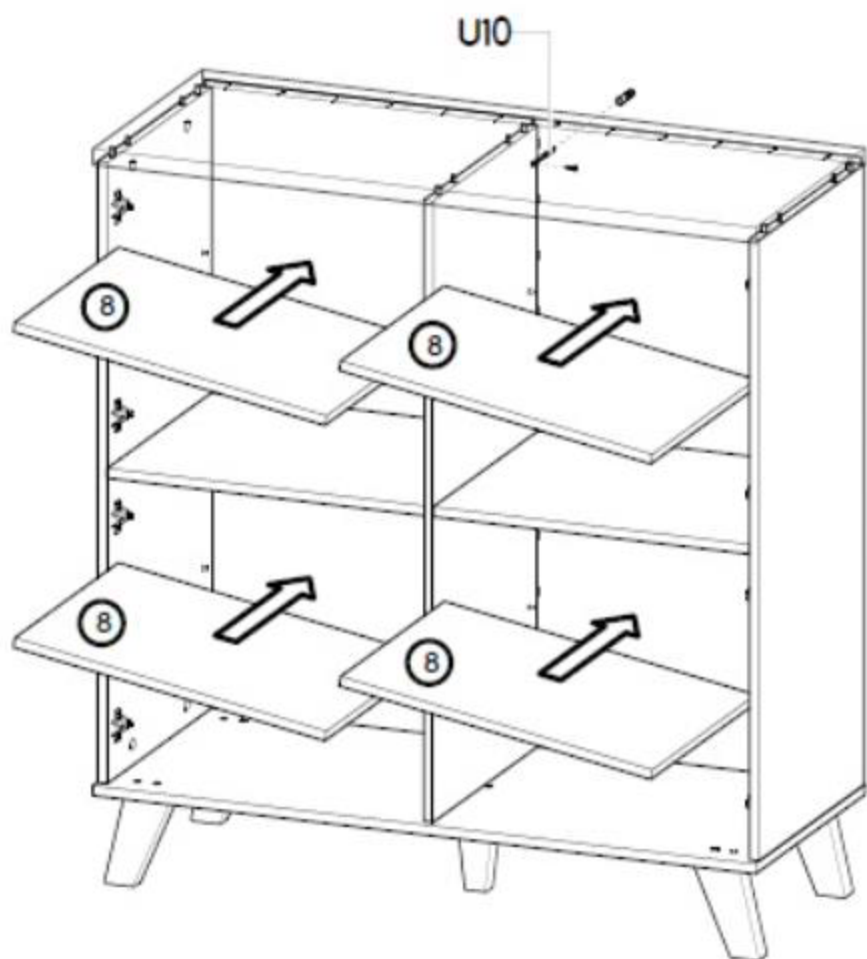

VI

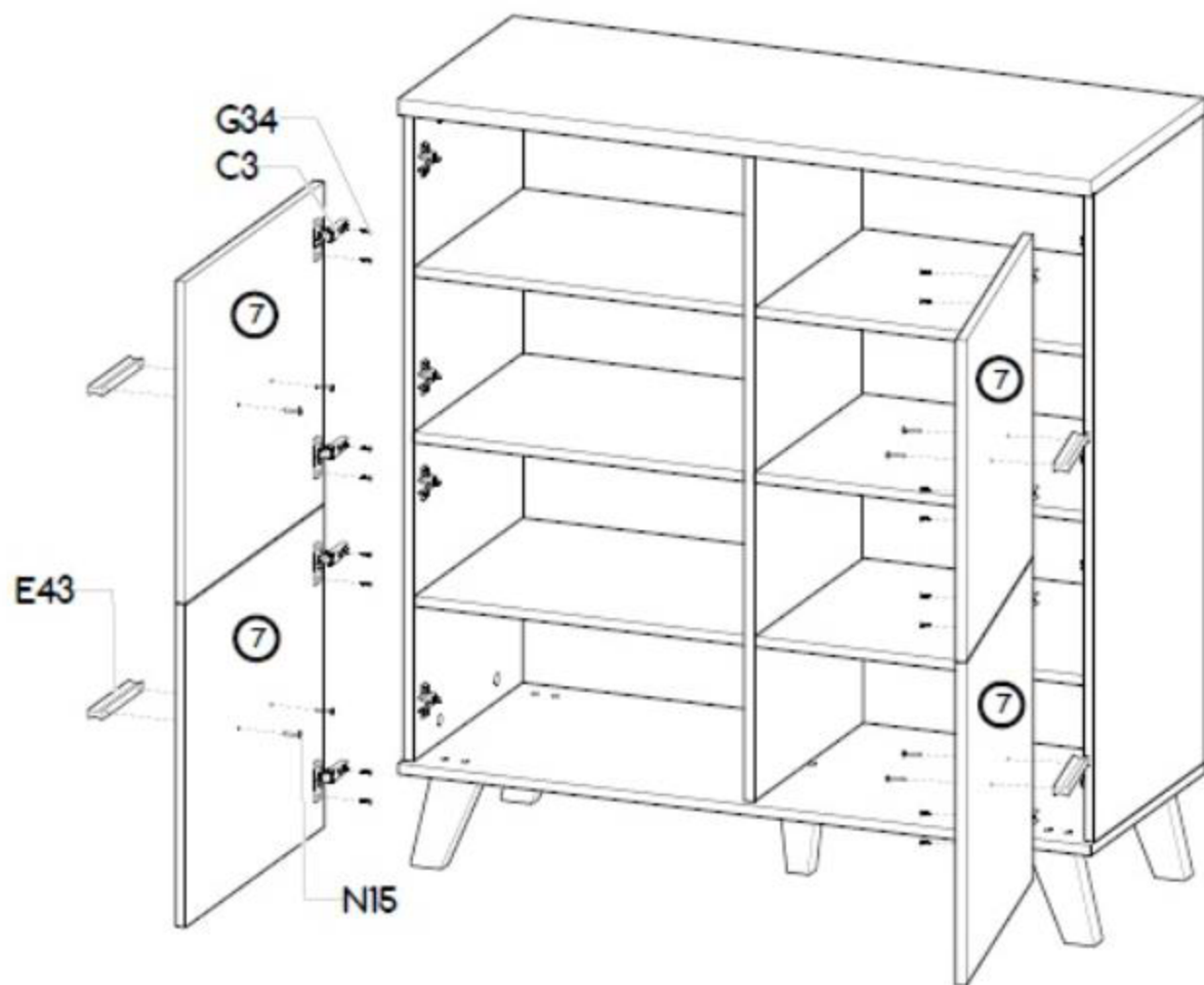

III

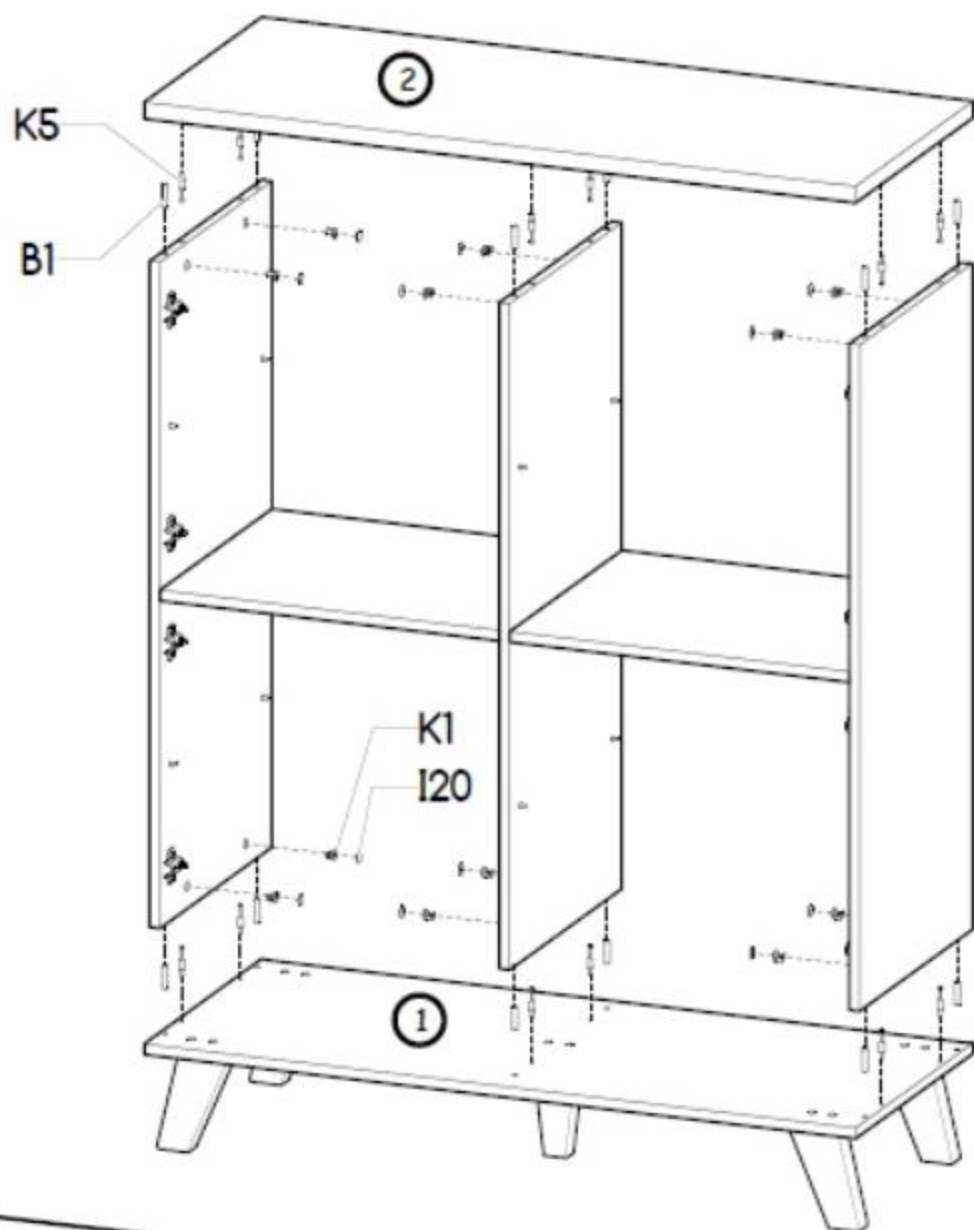

IV

