

④ = max 3kg

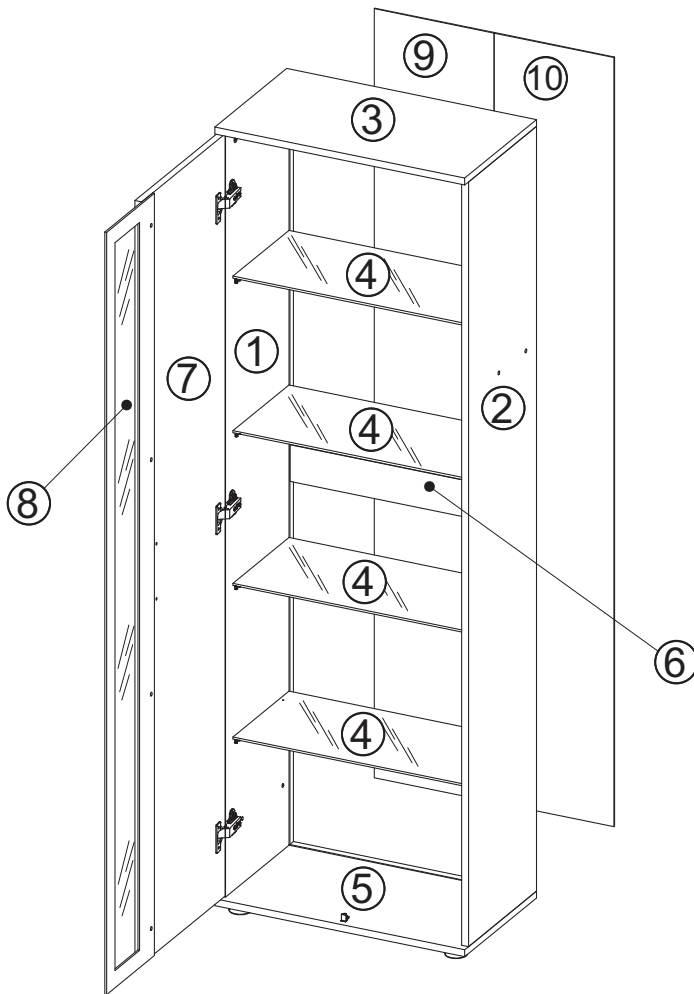

**Led**

x4

le

x...(x1)

**a1**

8x35

x...(x10)

**b0**

x...(x3)

**b1**

x...(x3)

**d3**

x...(x18)

**e0**

x...(x6)

**e1**

x...(x6)

**f1**

x...(x6)

**g1**

7x50

x...(x6)

**h1**

x...(x1)

**i2**

4x16

x...(x4)

**k5**

4x30

x...(x2)

**m**

x...(x1)

**n1**

3,5x16

x...(x7)

**o18**

x...(x4)

**q**

x...(x1)

**r3**

x...(x4)

**r4**

x...(x12)



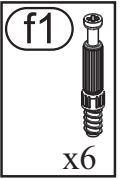
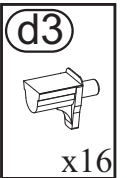
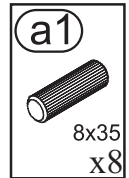
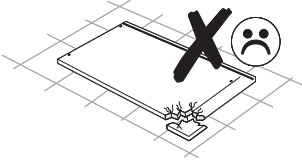
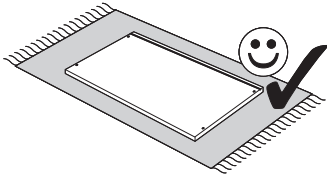

1

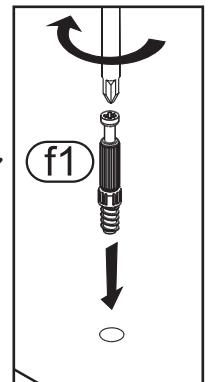
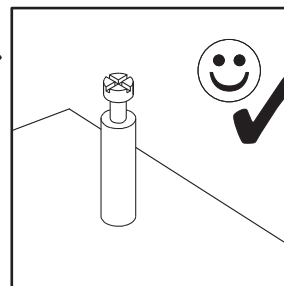
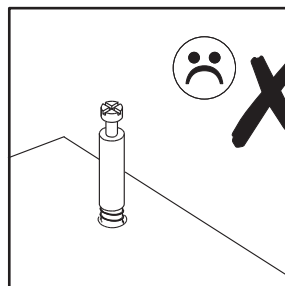
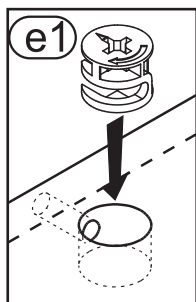
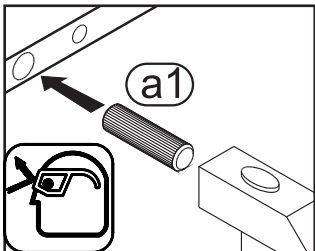
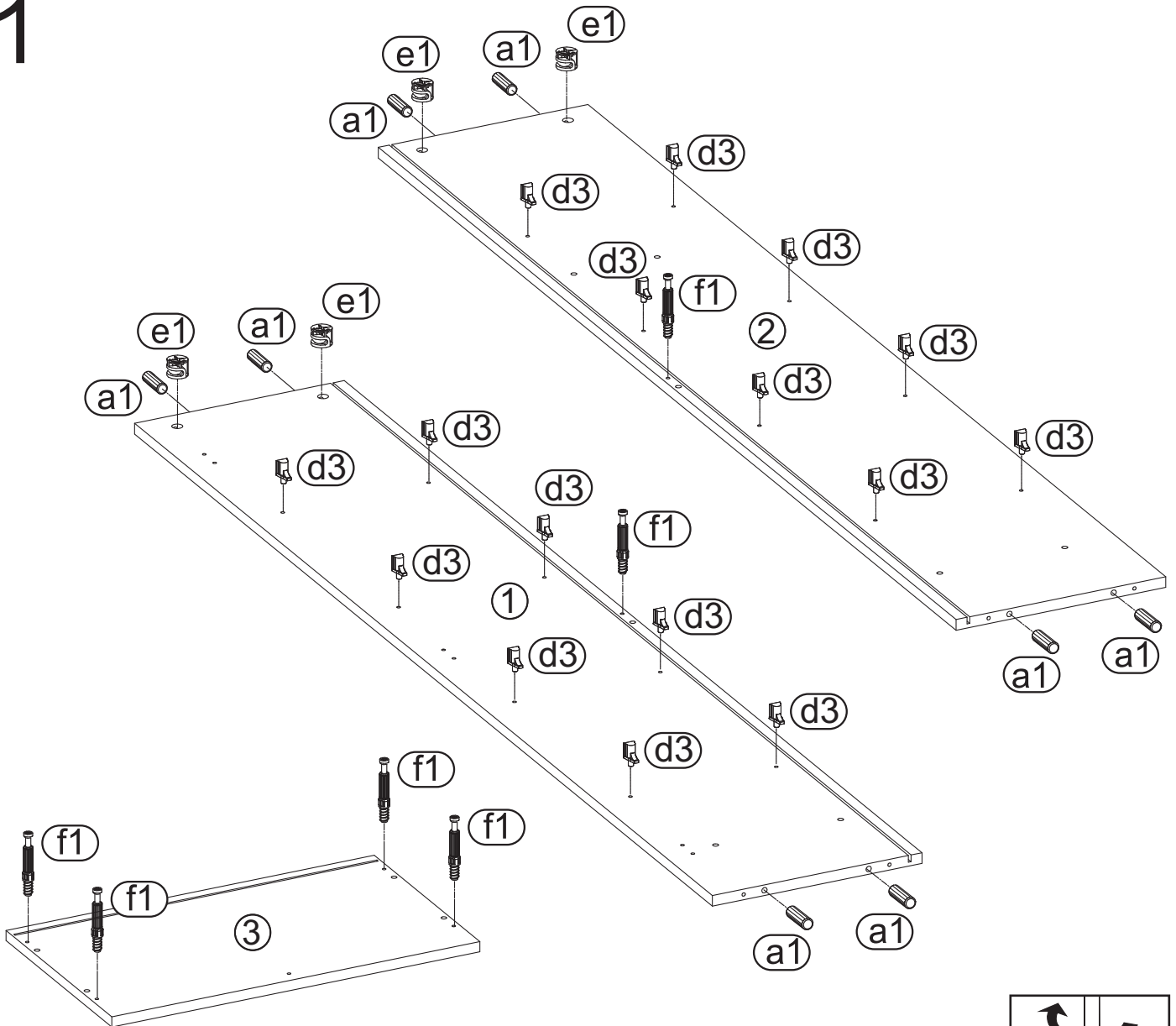

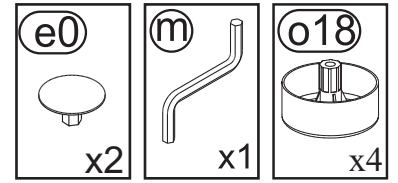
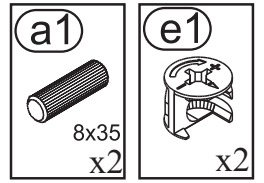
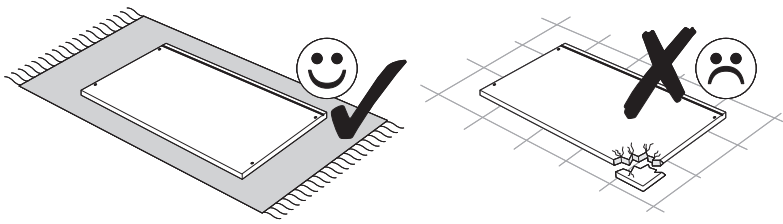

2

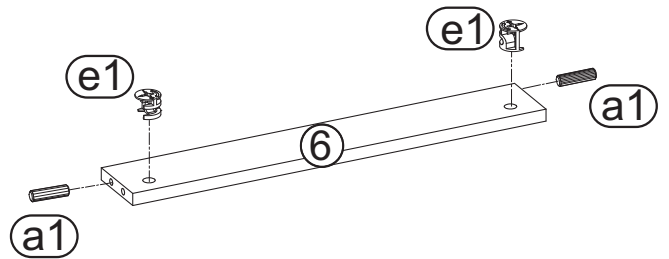
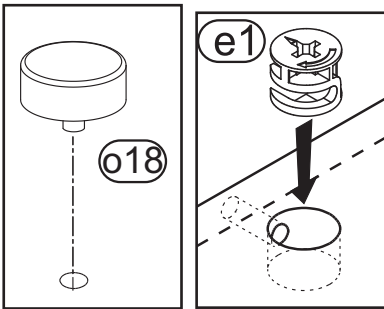
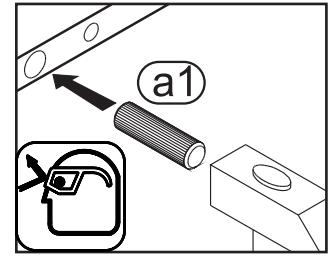
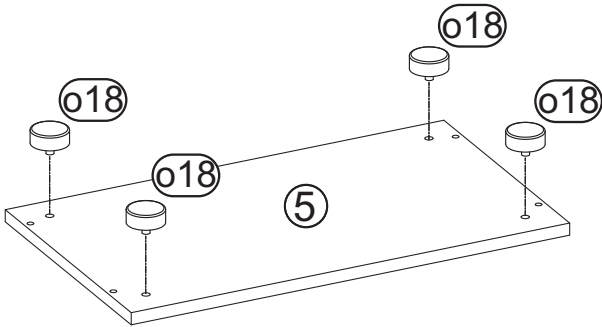

3

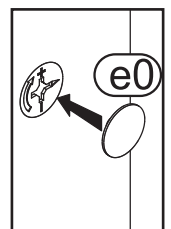
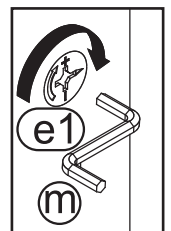
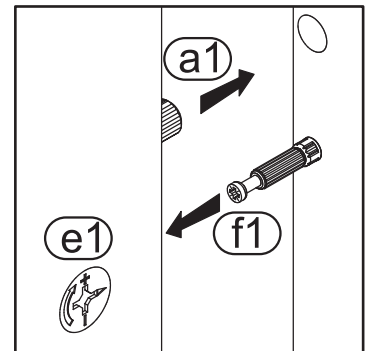
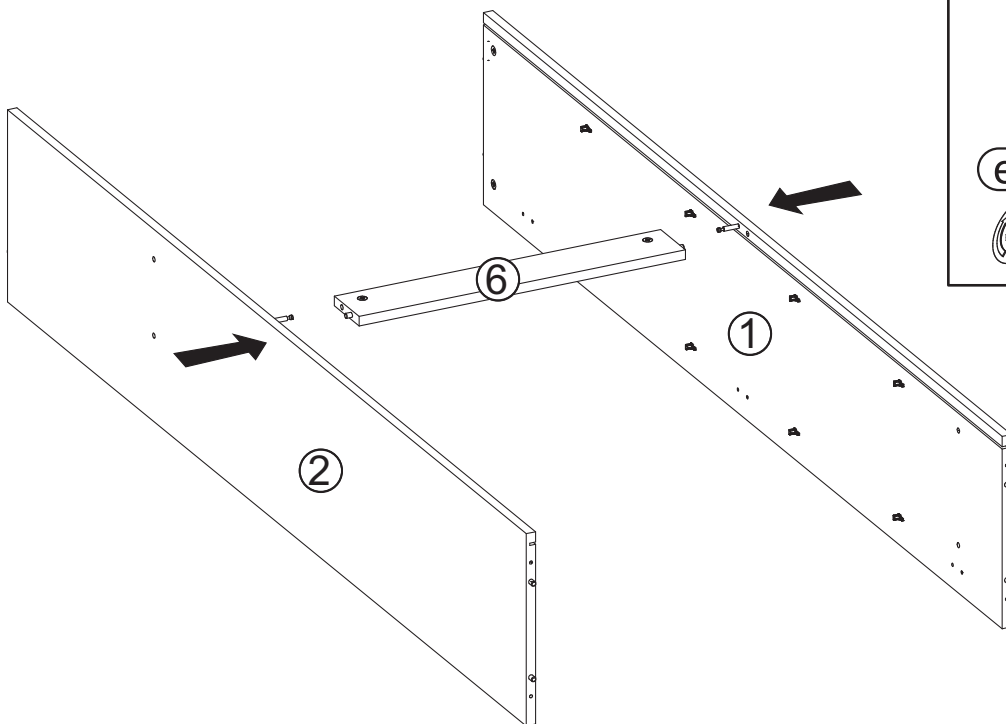

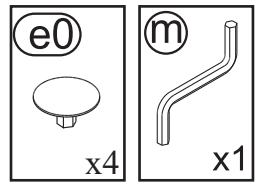
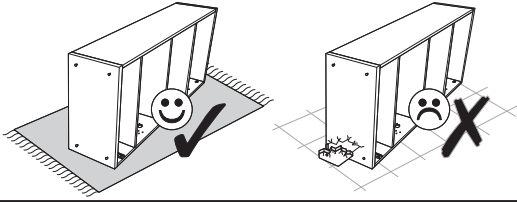

4

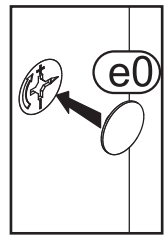
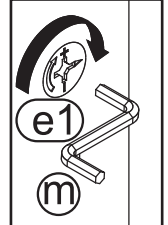
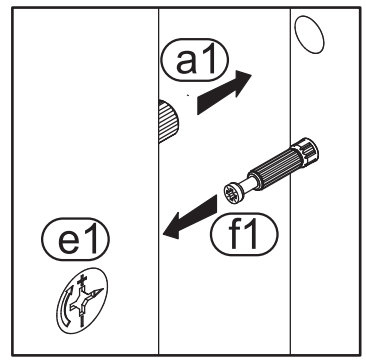
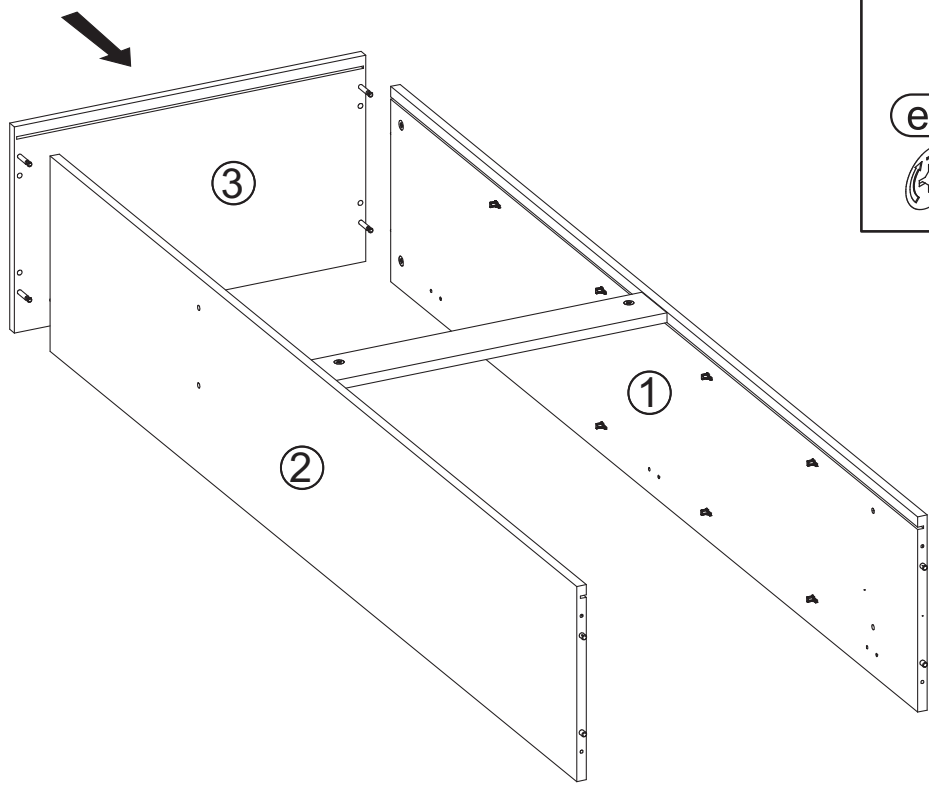

5

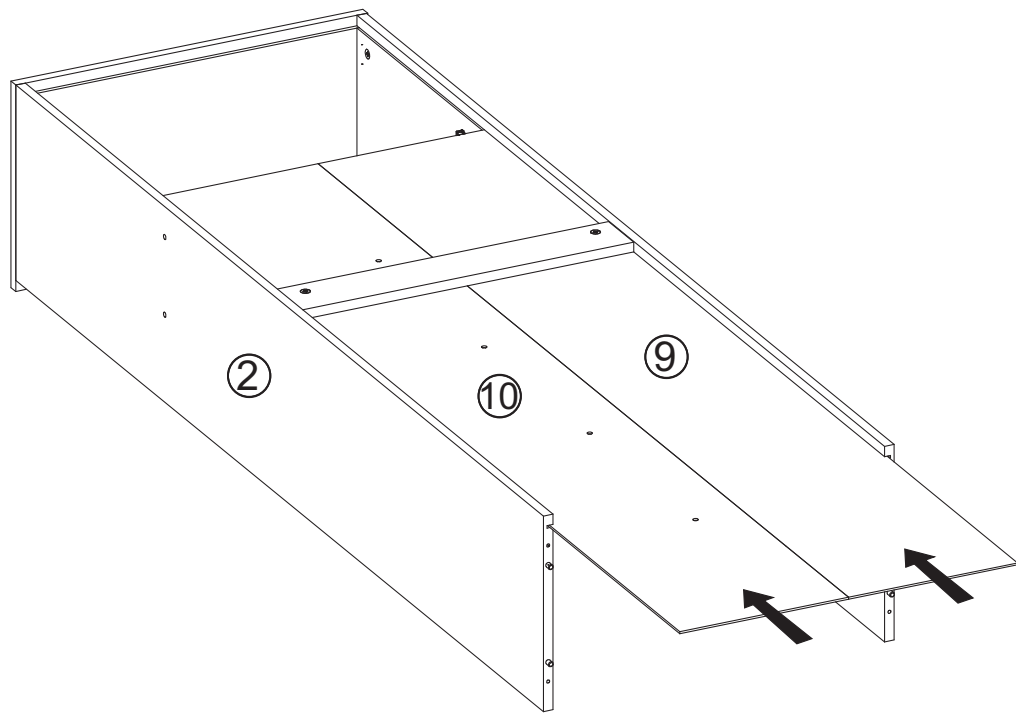

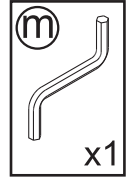
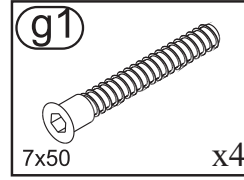
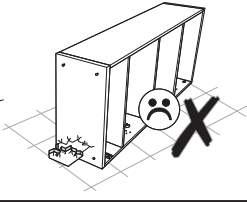
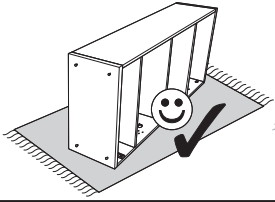

6

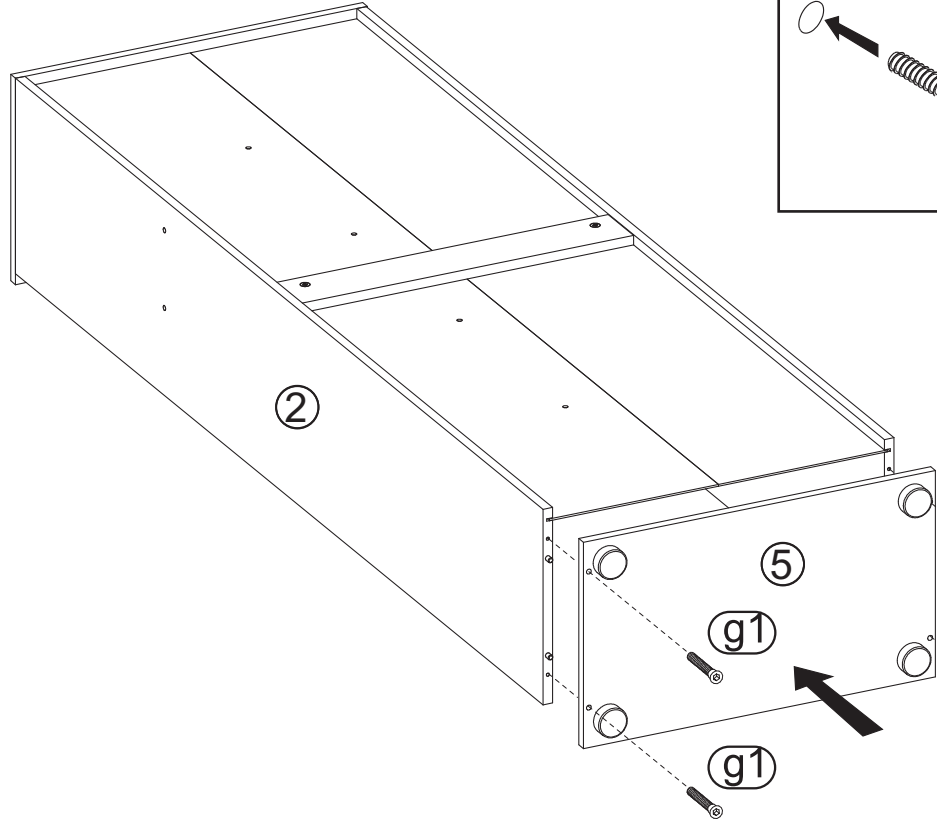

7

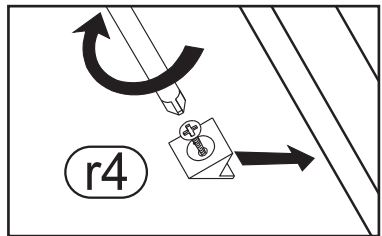
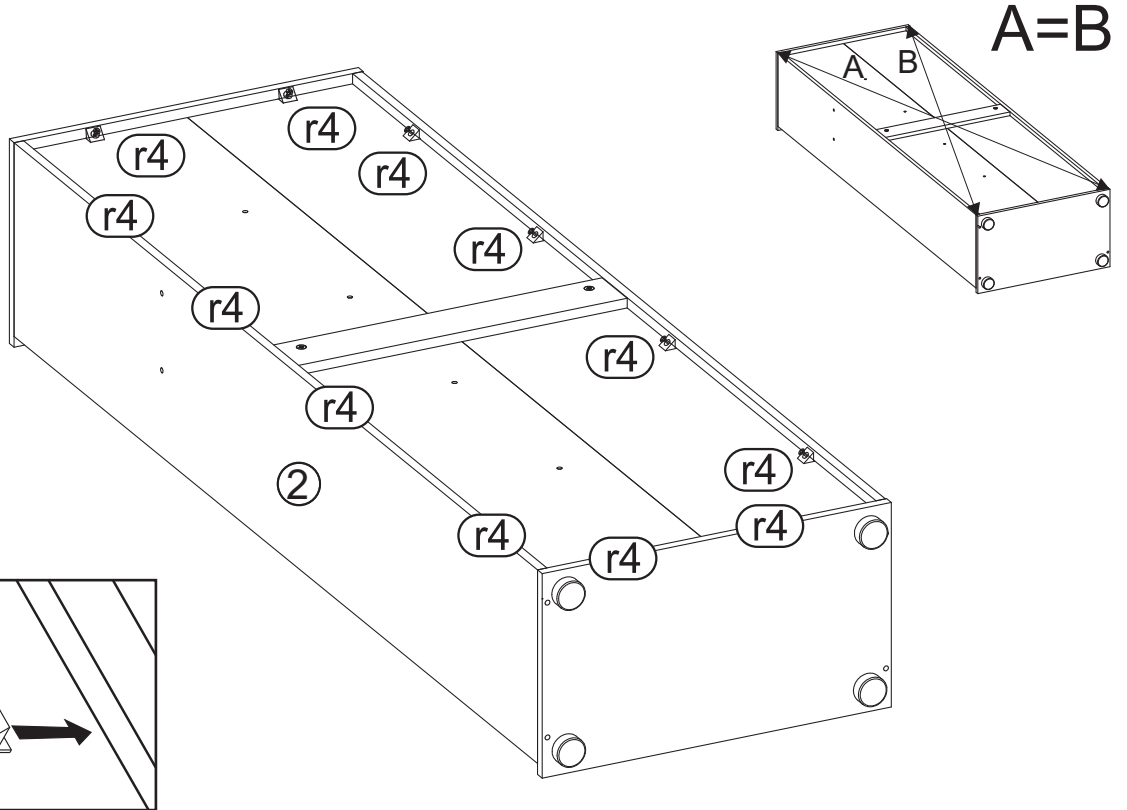

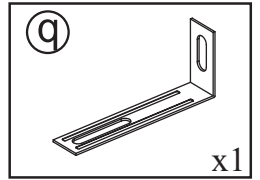
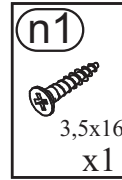
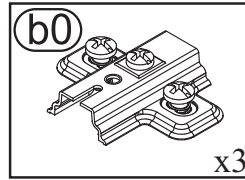
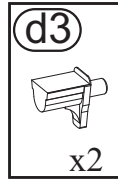
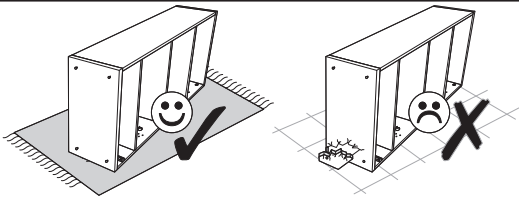

# 8

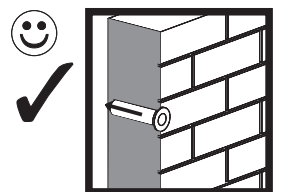
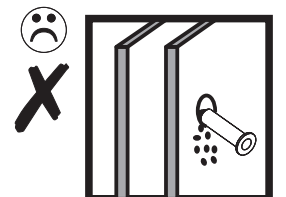
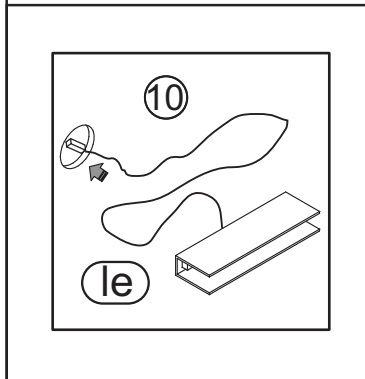
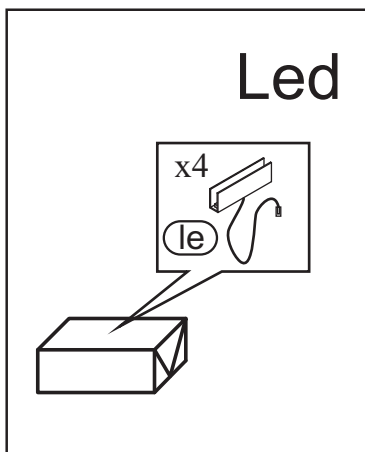
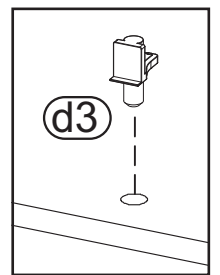
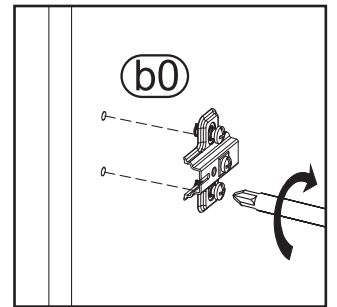
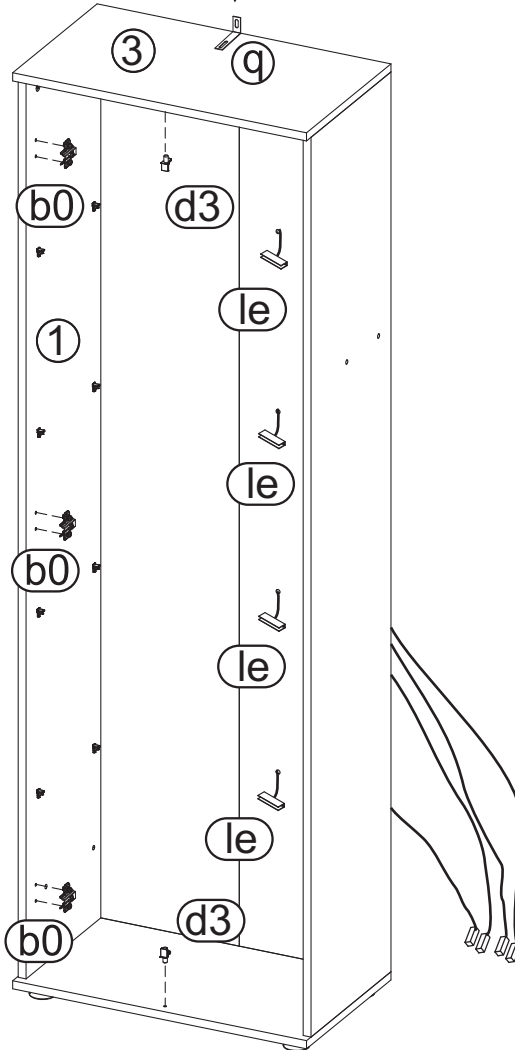
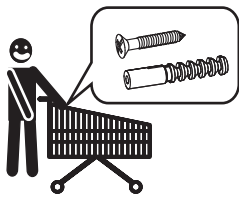
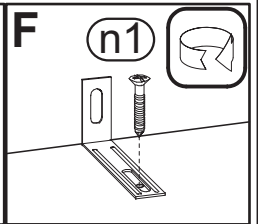
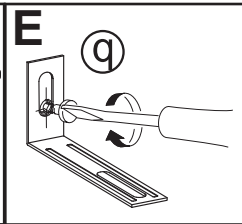
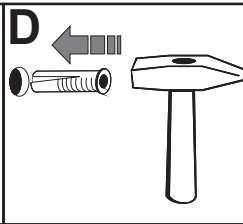
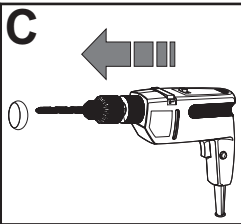
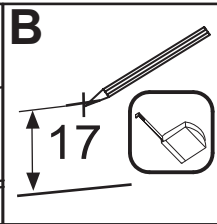
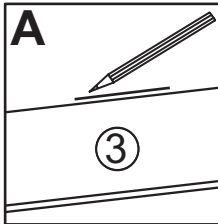

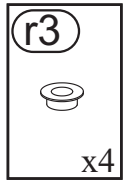
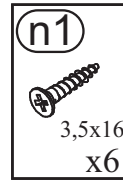
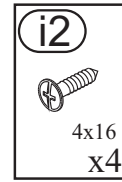
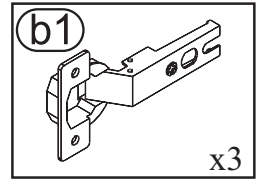
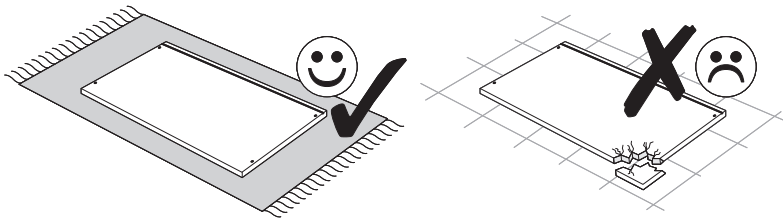

# 9

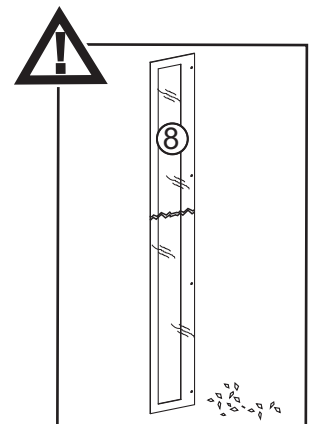
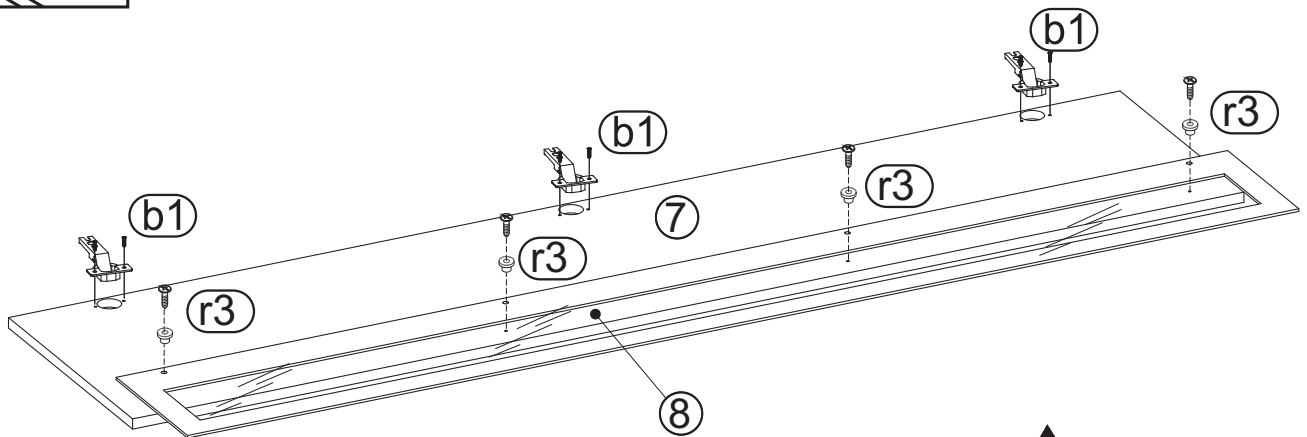
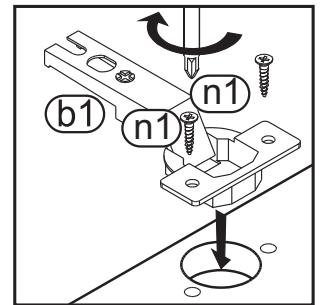
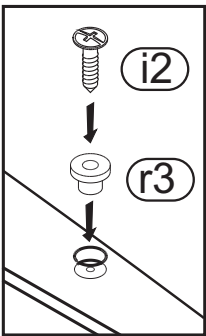



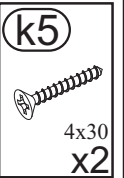
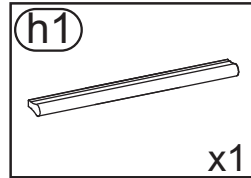
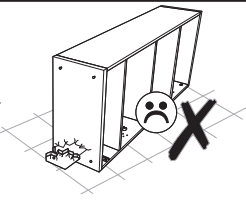
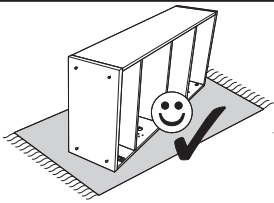

10

