

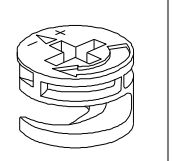

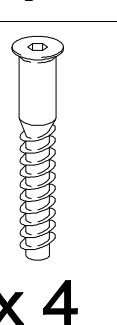
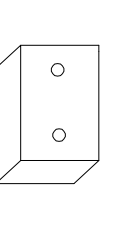
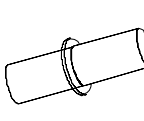
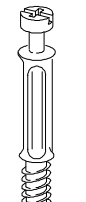
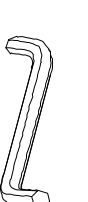
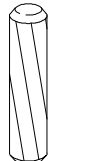

### BA- R3

A	550x380x18	2
B	1959x380x18	2
C	550x65x18	2
D	1866x65x18	2
E	513x376x18	4
F	1982x536x4	1

a	b	c	d	e	f	g	o	p	s	t
										
		x 28	x 4						x 4	
										
x 8	x 28	x 1		x 26		x 60			x 8	
j	k	l	m	n	h	i		r	w	z

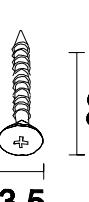
### BA- R2

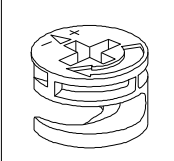
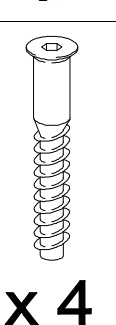
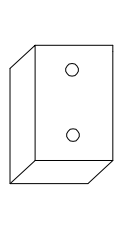
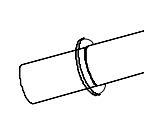
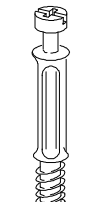
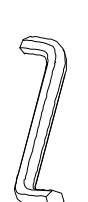
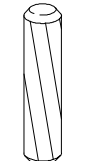
A	850x380x18	2
B	1959x380x18	2
C	850x65x18	2
D	1866x65x18	2
E	813x376x18	4
F	1982x417,5x4	2

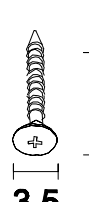
a	b	c	d	e	f	g	o	p	s	t
										
		x 28	x 4						x 5	
										
x 8	x 28	x 1		x 26		x 60			x 10	
j	k	l	m	n	h	i		r	w	z

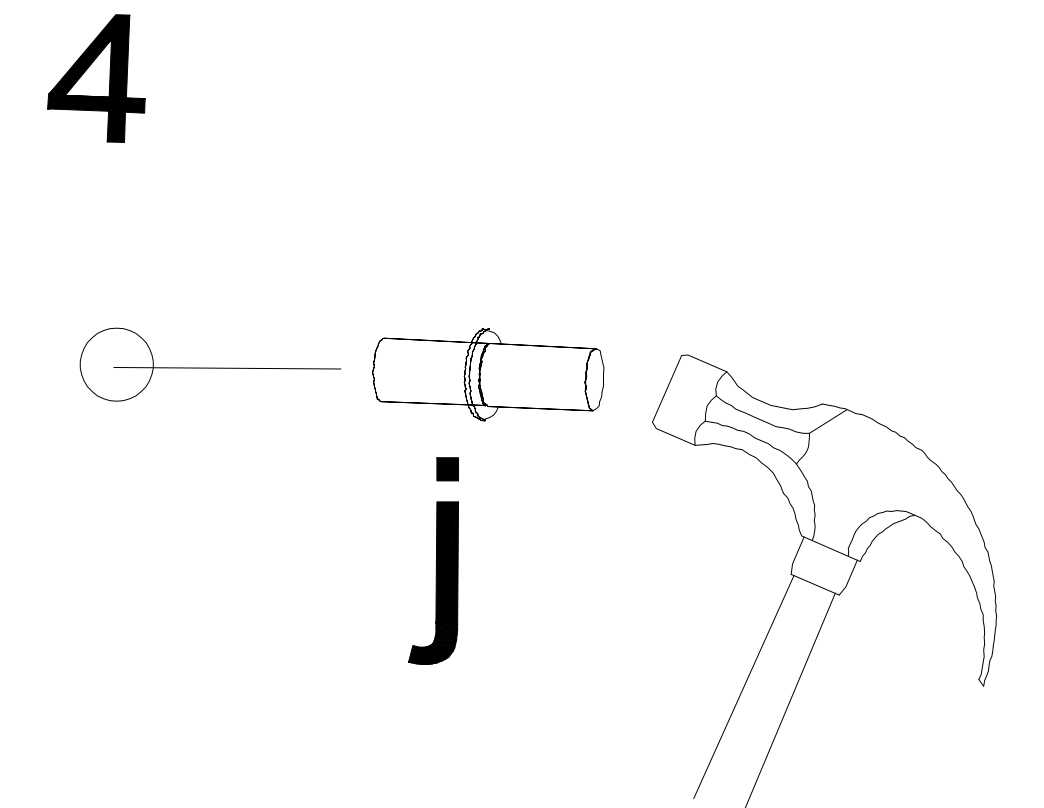
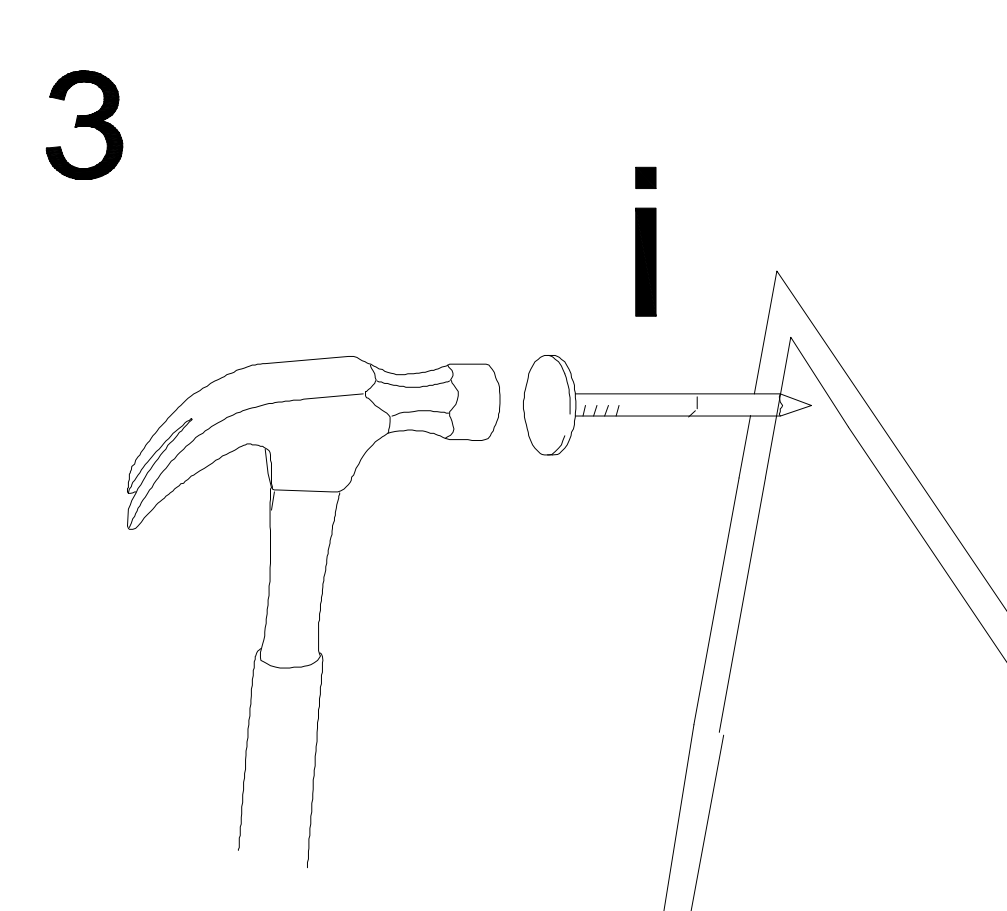
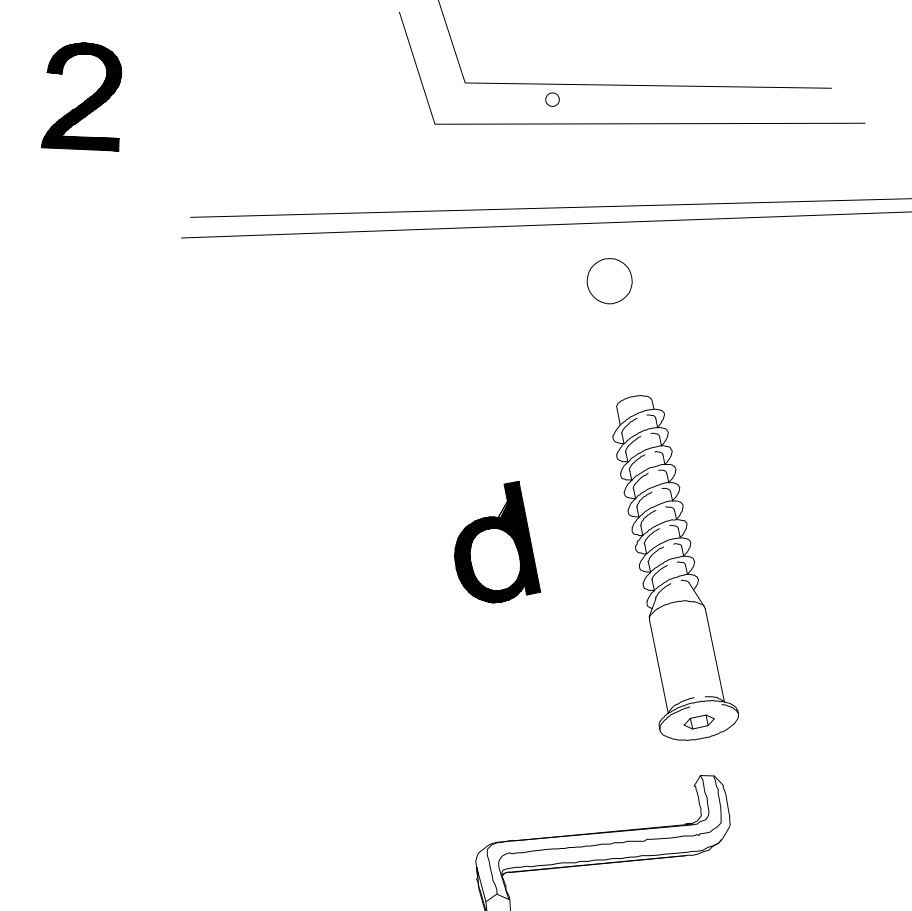
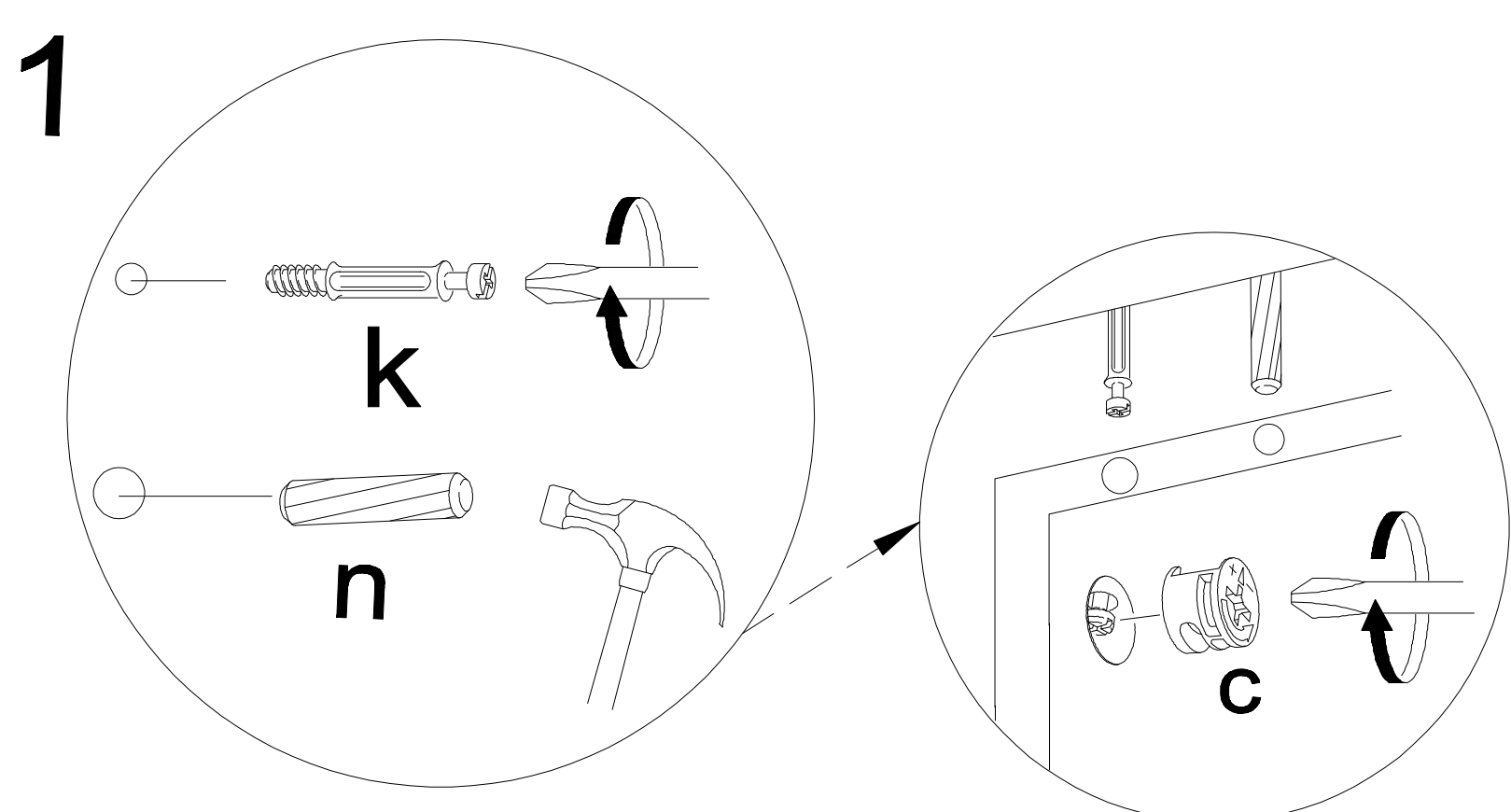

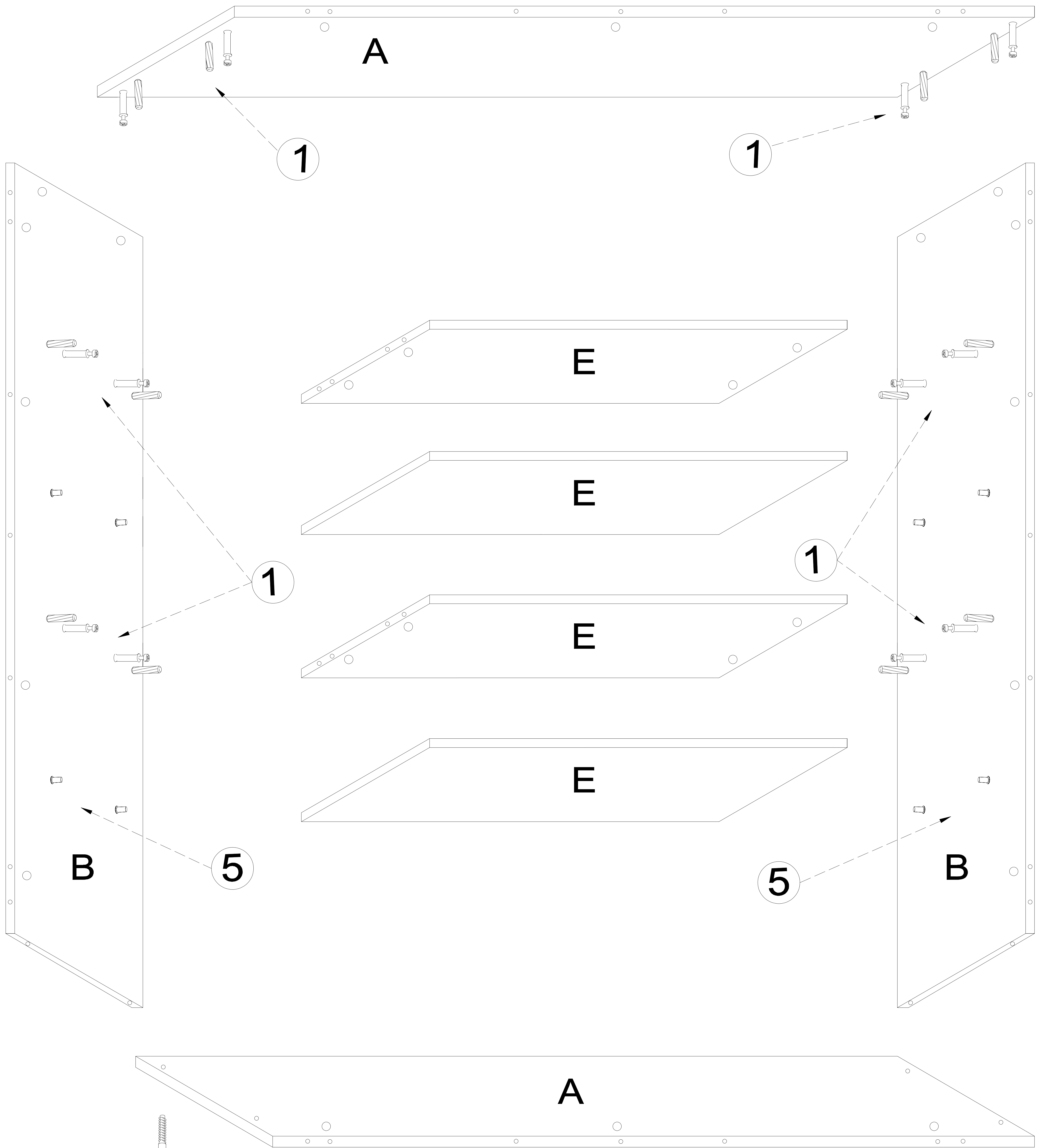
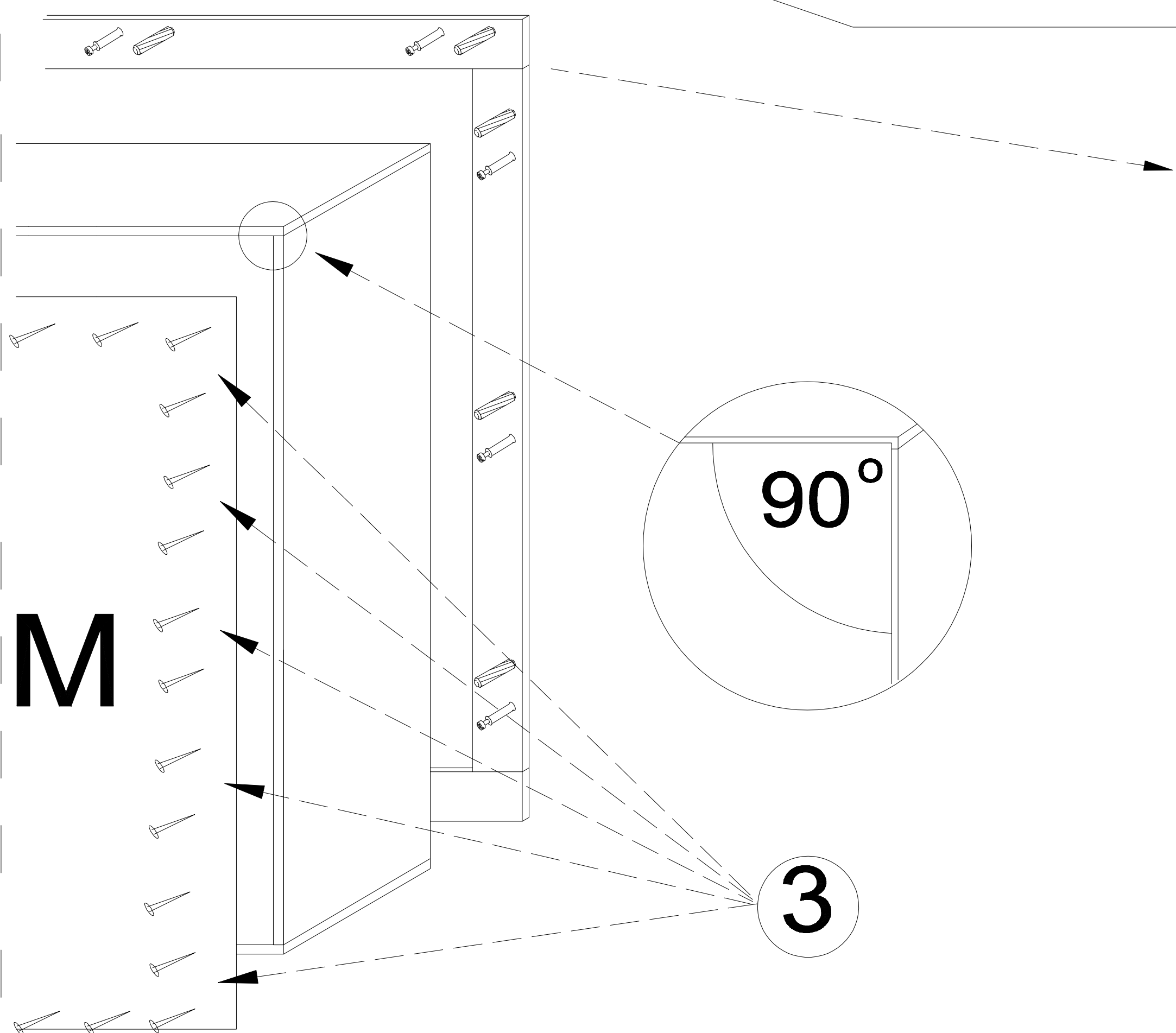
**I****II****III**