







①

5	20
	
NR	W15

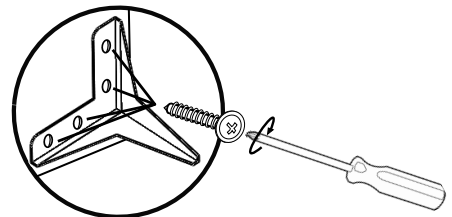
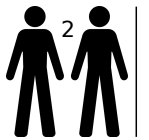
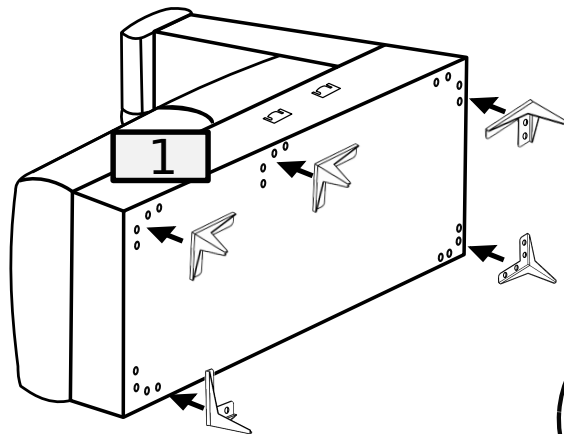

2

2	8	4	2
			
NR	W15	W16	ND

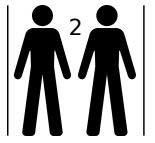
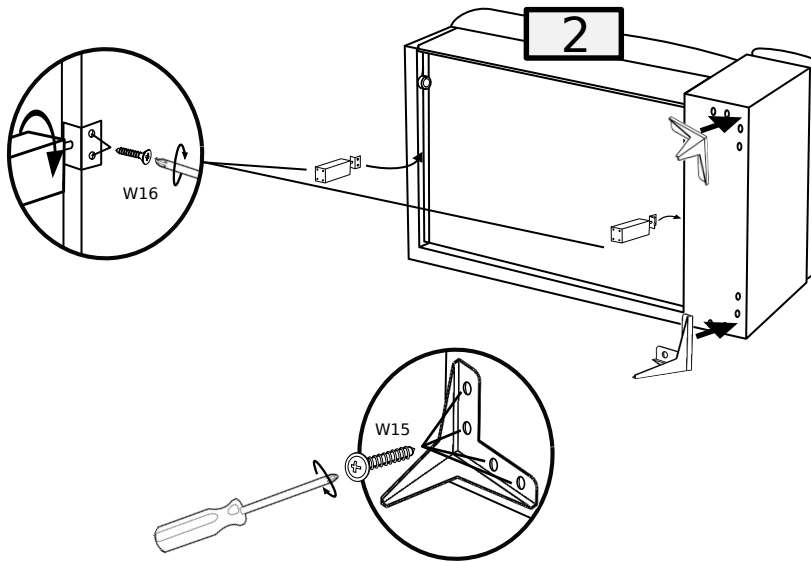

3

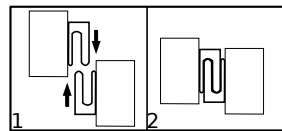
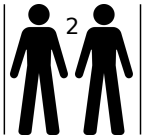
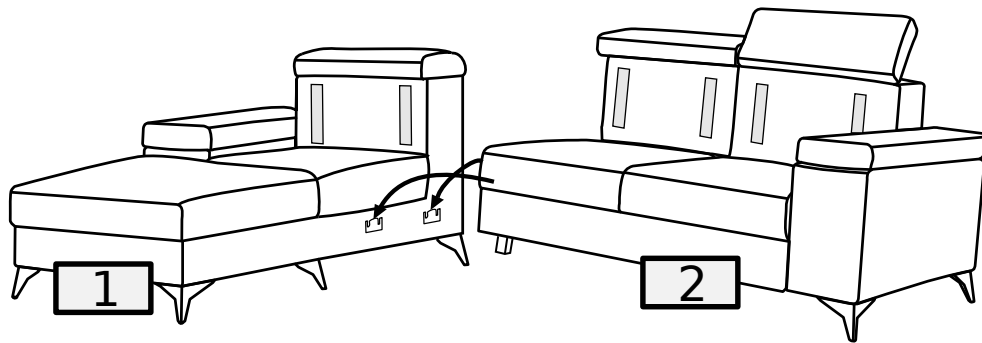

4

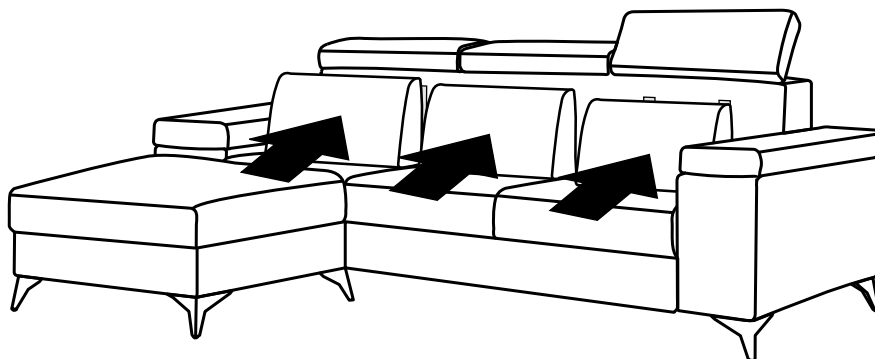

5

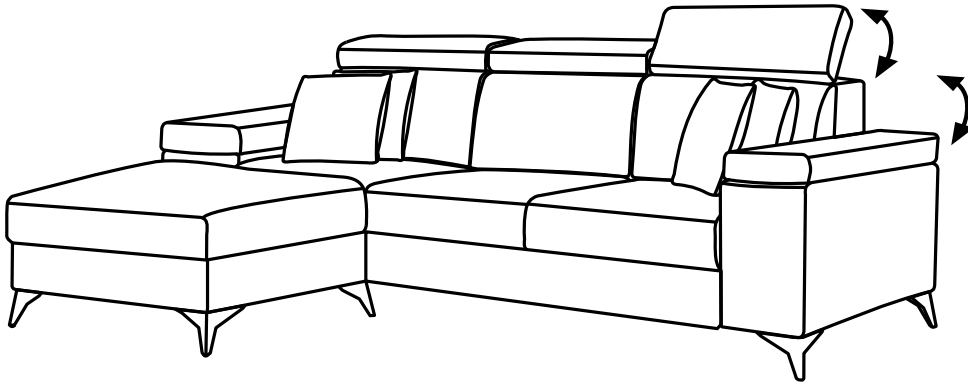

0

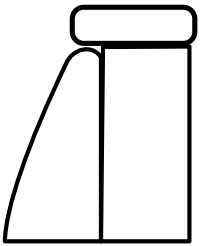

1

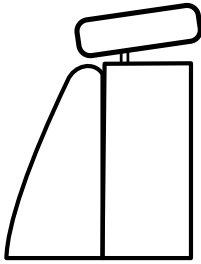

2

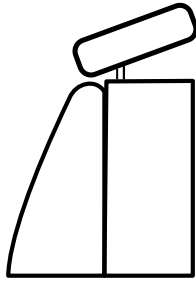

3

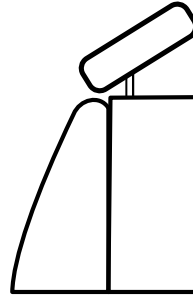

4

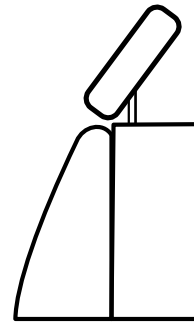

5

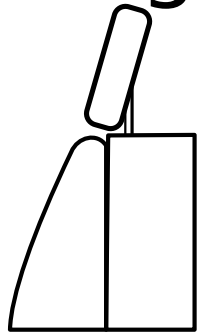

6

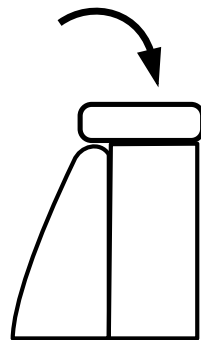
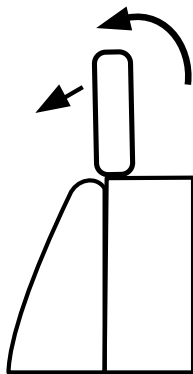

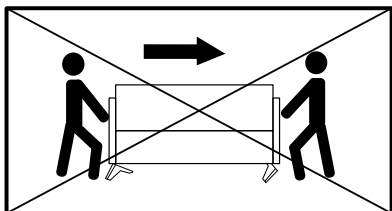
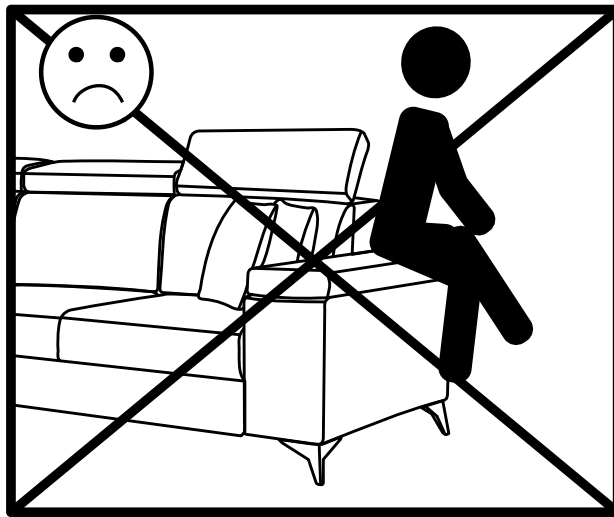
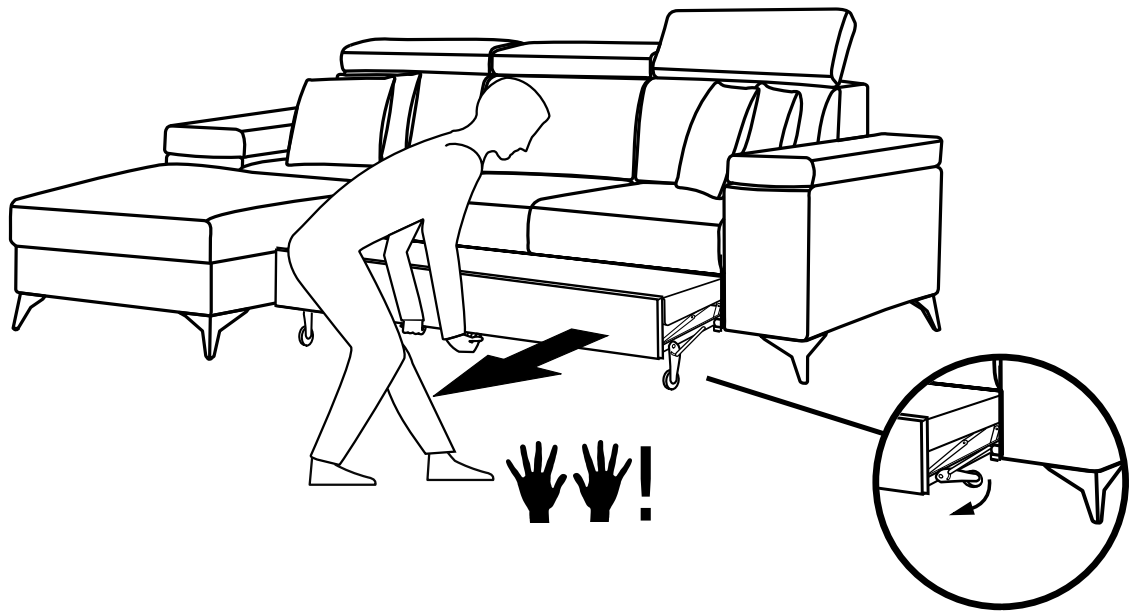

×

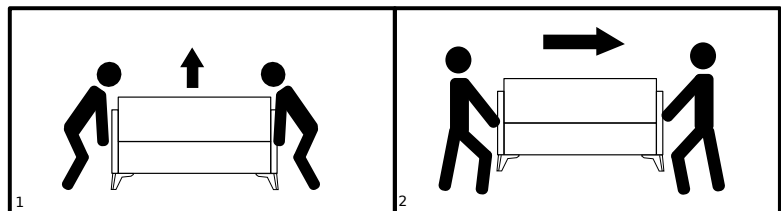

✓