

2	4	10	8	4
PZ	O	I	S3 ø5	X2
LT W	RT W	4.0x30 W8	WI	U1
1	1	4	2	1

16	16	12	4	
B	A	8.0x35	D 3.5x16 W2	
X 3.5x25 W10	W10	UO	Z	X3
8	2	1	2	4

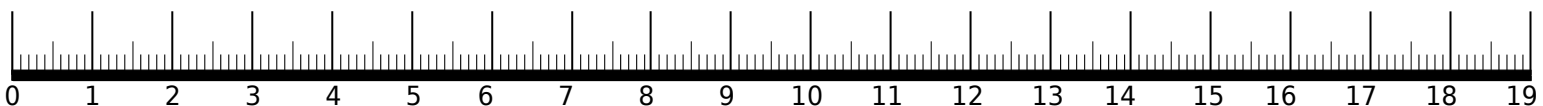

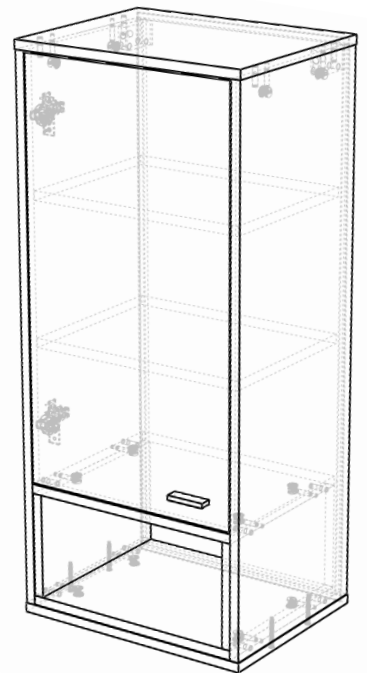
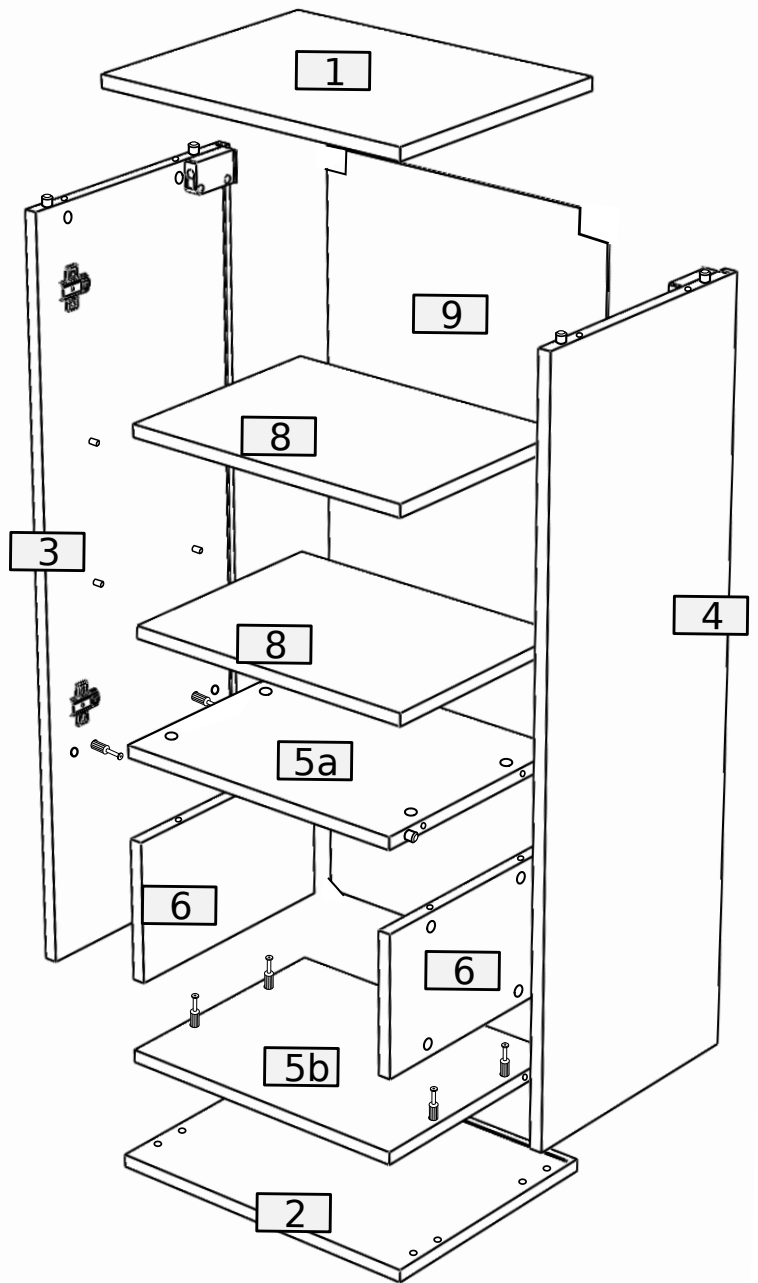
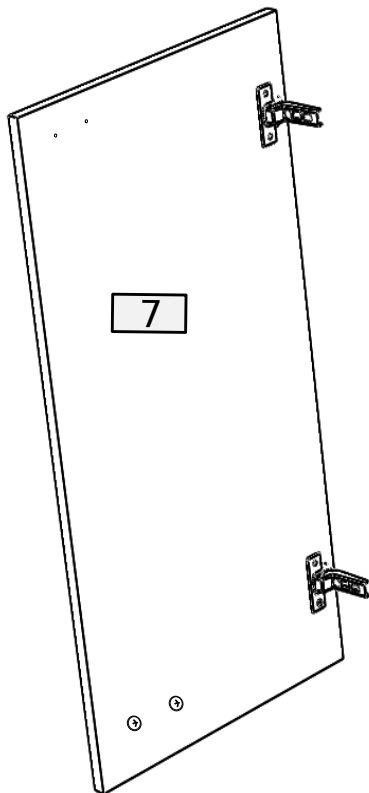

No.	Pcs.	L	W	D	Pac
1	1	420	330	16	1/1
2	1	420	330	16	1/1
3	1	930	328	16	1/1
4	1	930	328	16	1/1
5a	2	386	308	16	1/1
5b	2	386	308	16	1/1
6	2	307	180	16	1/1
7	1	712	382	16	1/1
8	2	386	290	16	1/1
9	1	944	400	3	1/1

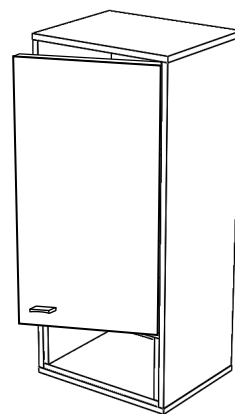

A

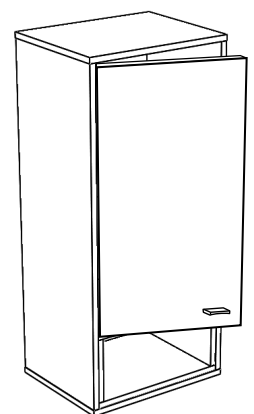

B

1

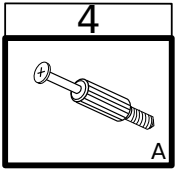
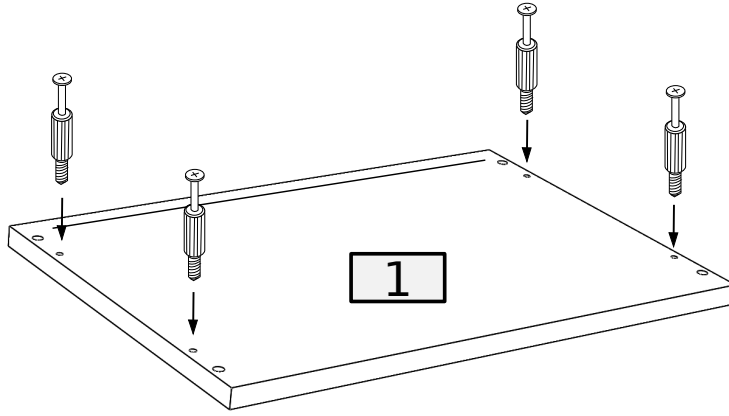

2

4	4	2	1	2
8.0x35	D	PZ	RT	W 4.0x30
4	2			
4	2			

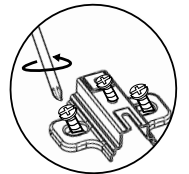
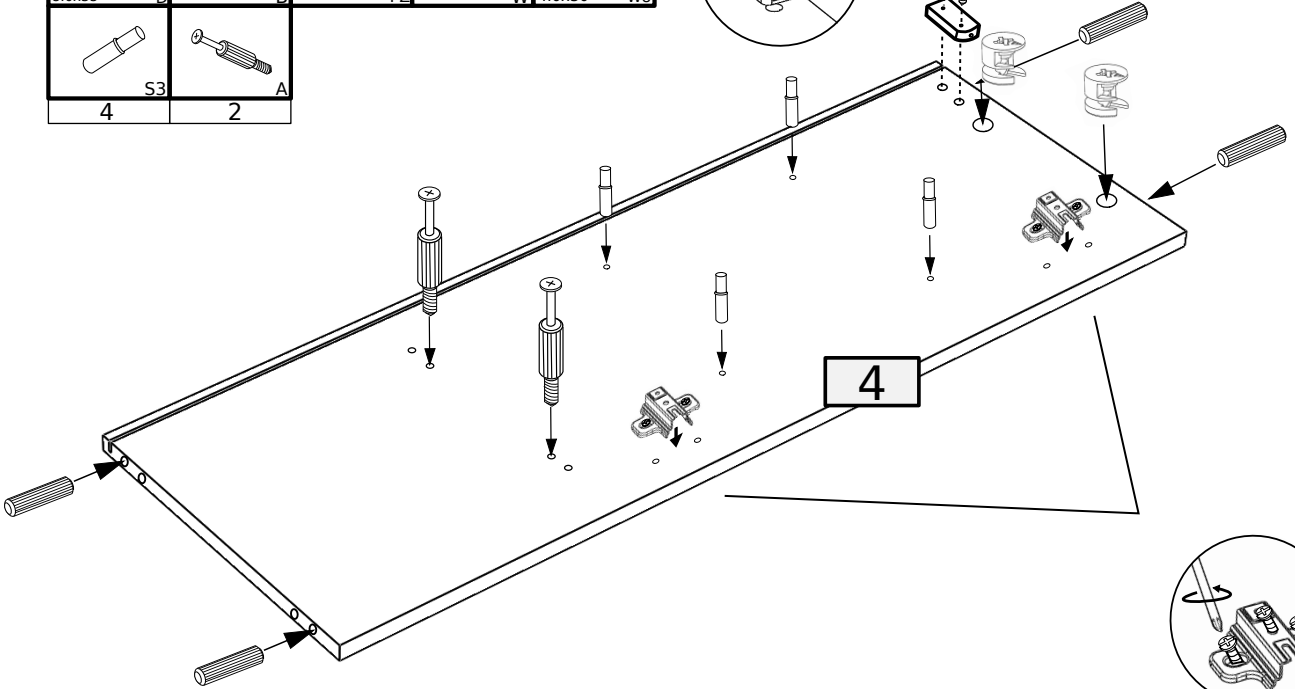
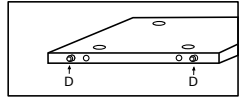
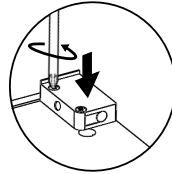

3

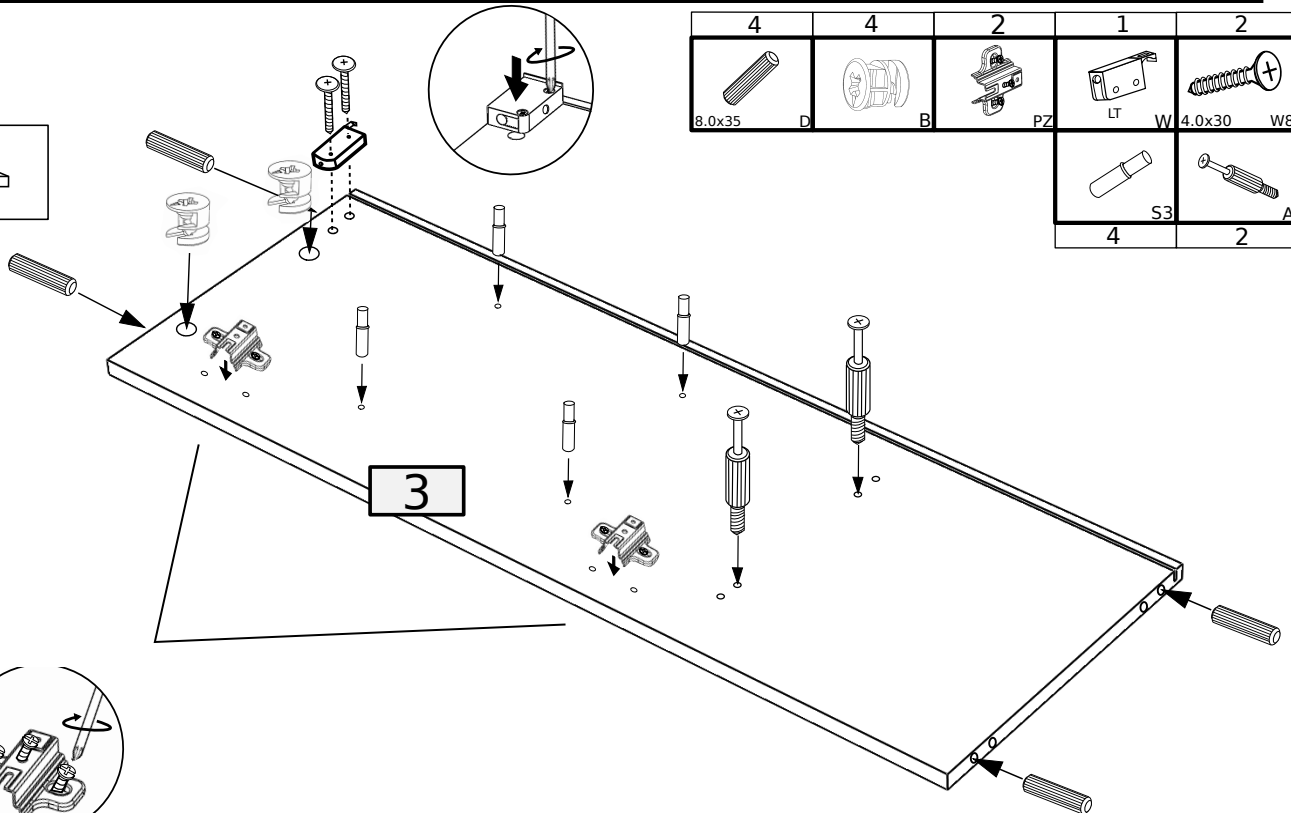
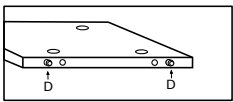

4	4	2	1	2
8.0x35	D	PZ	LT	W 4.0x30
4	2			
4	2			

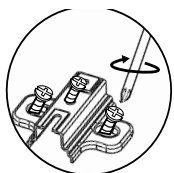

④ x2

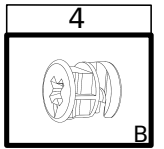
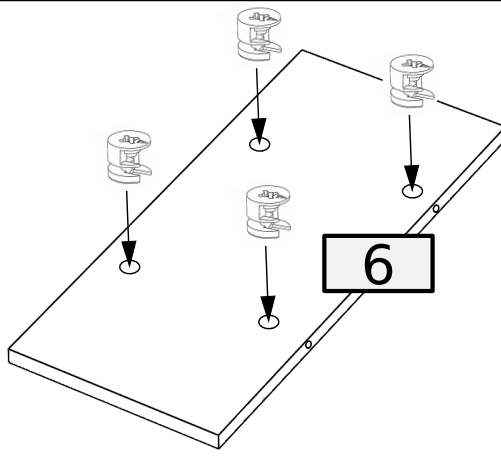
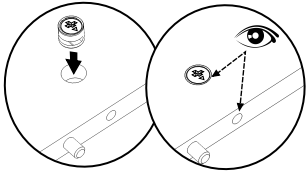

⑤

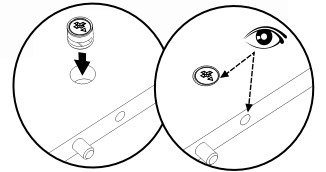
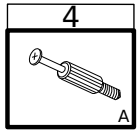
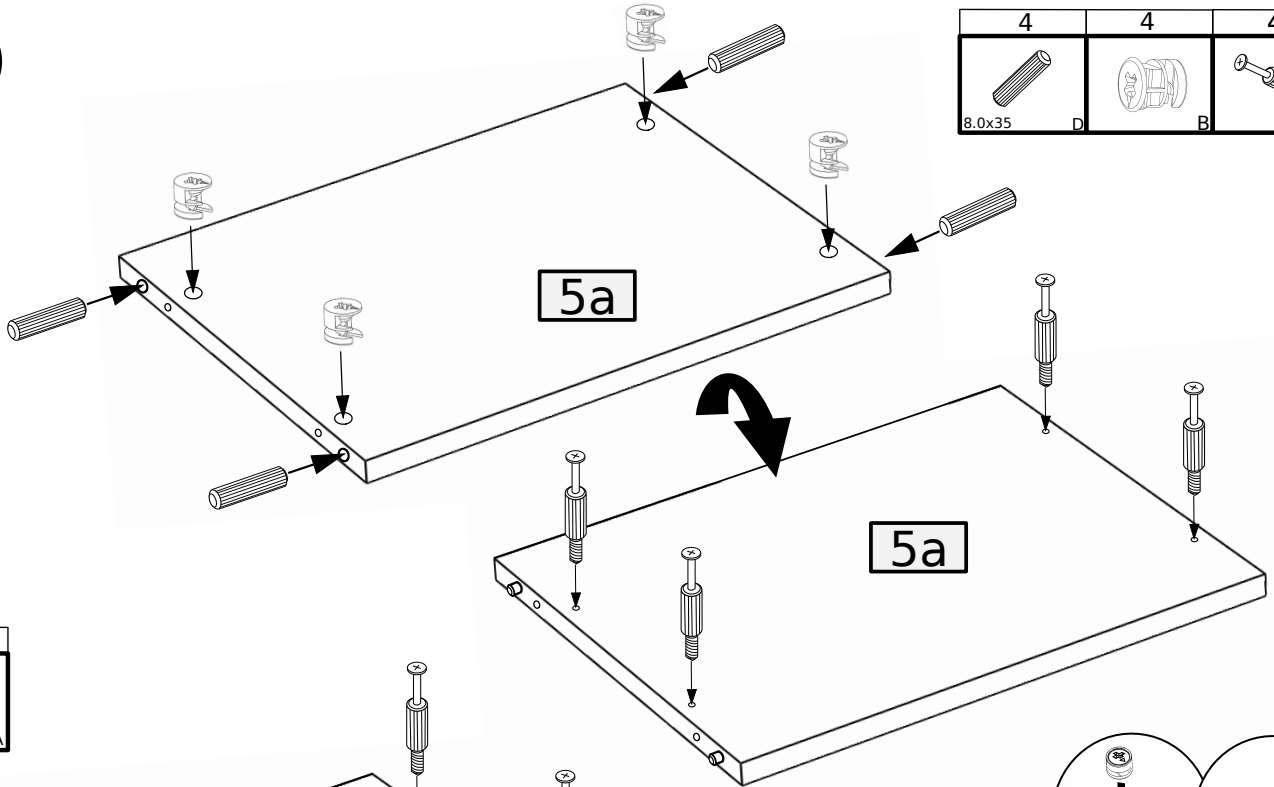
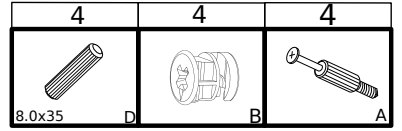

⑥

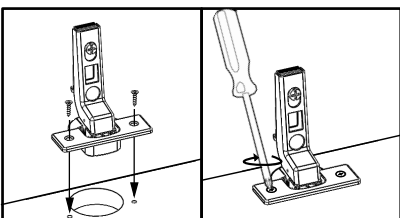
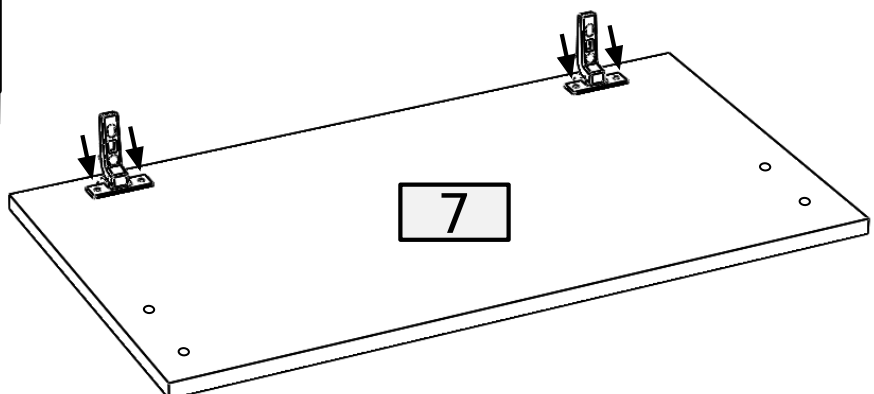
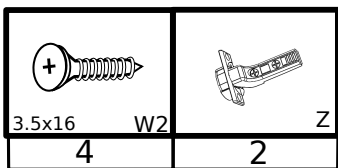

7

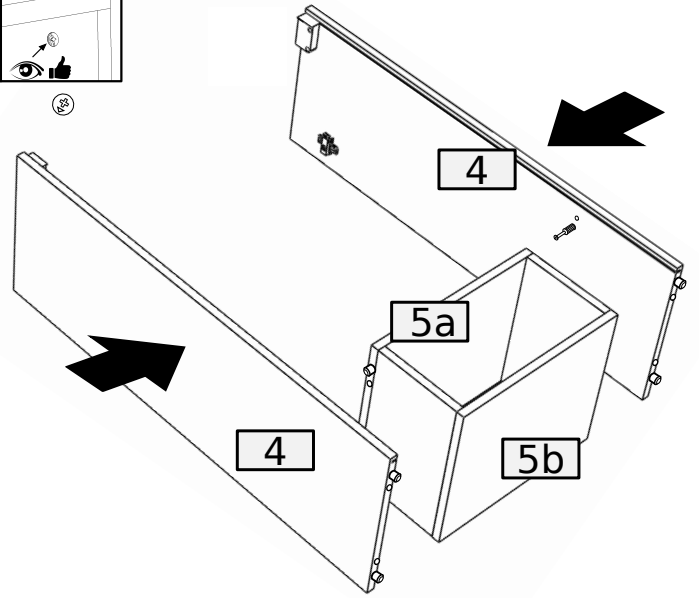
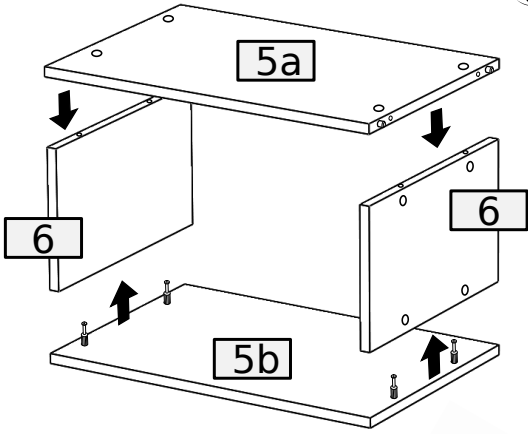
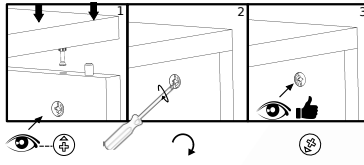

8

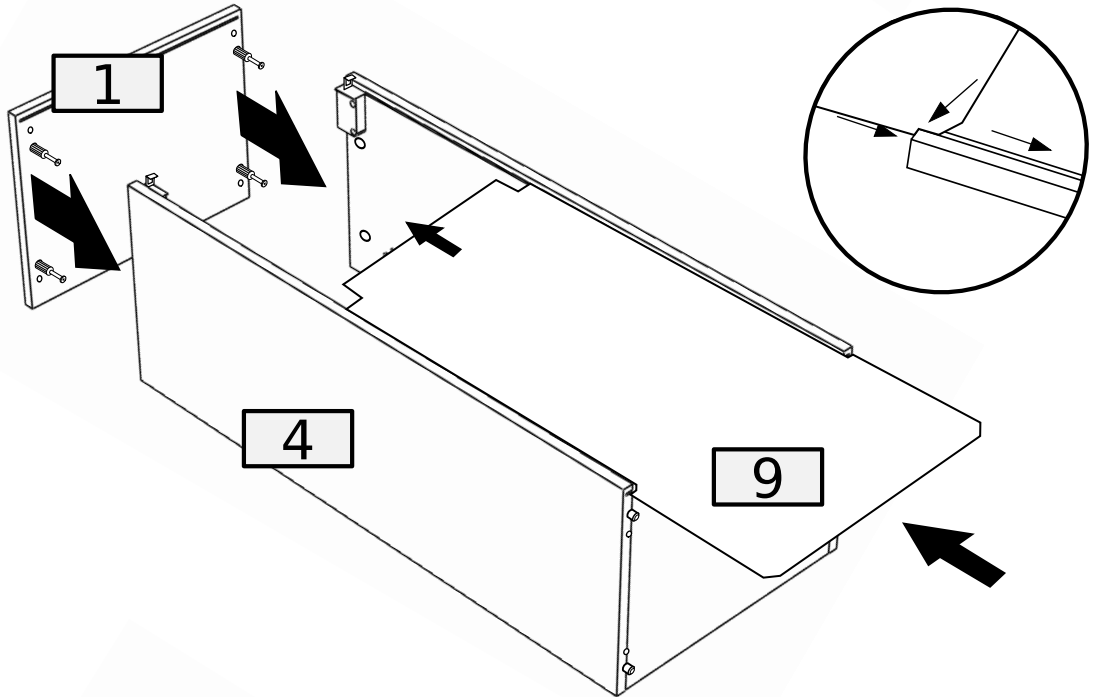

9

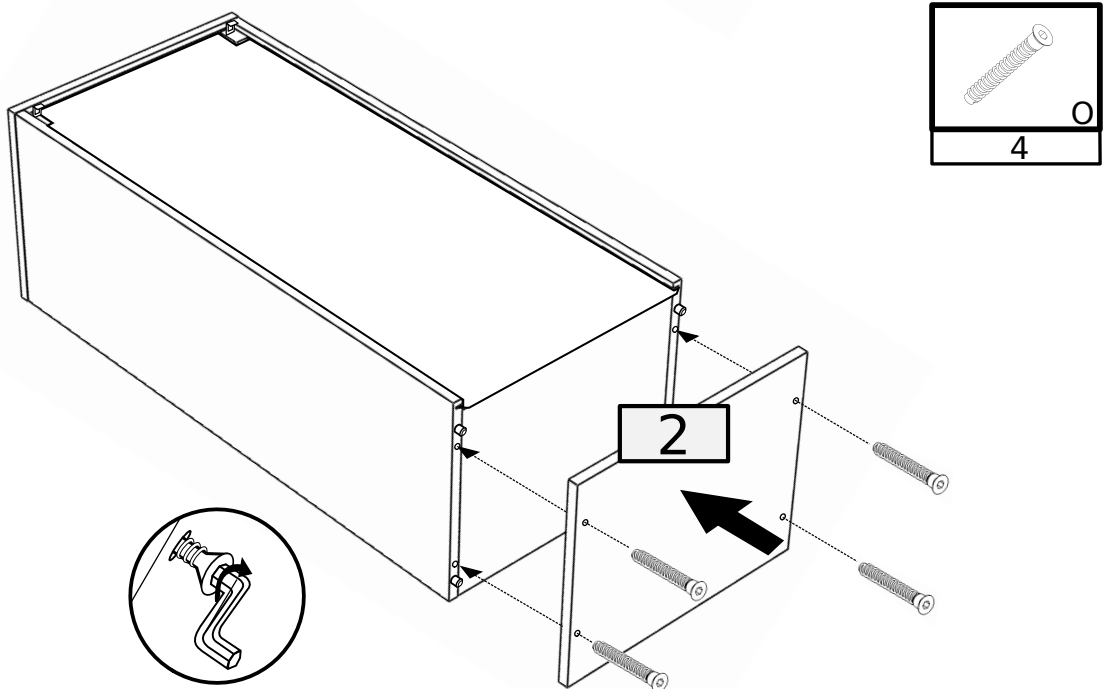

10

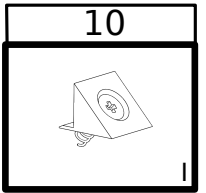
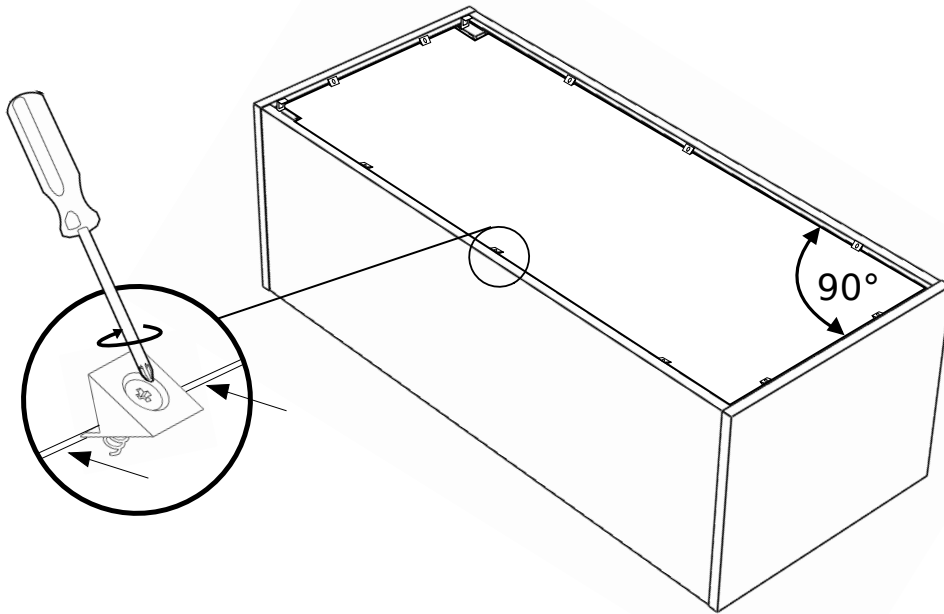

11

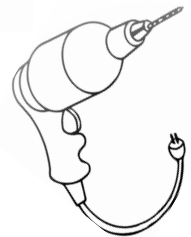
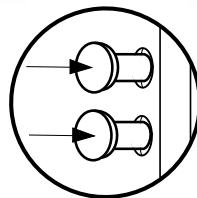
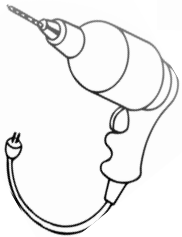
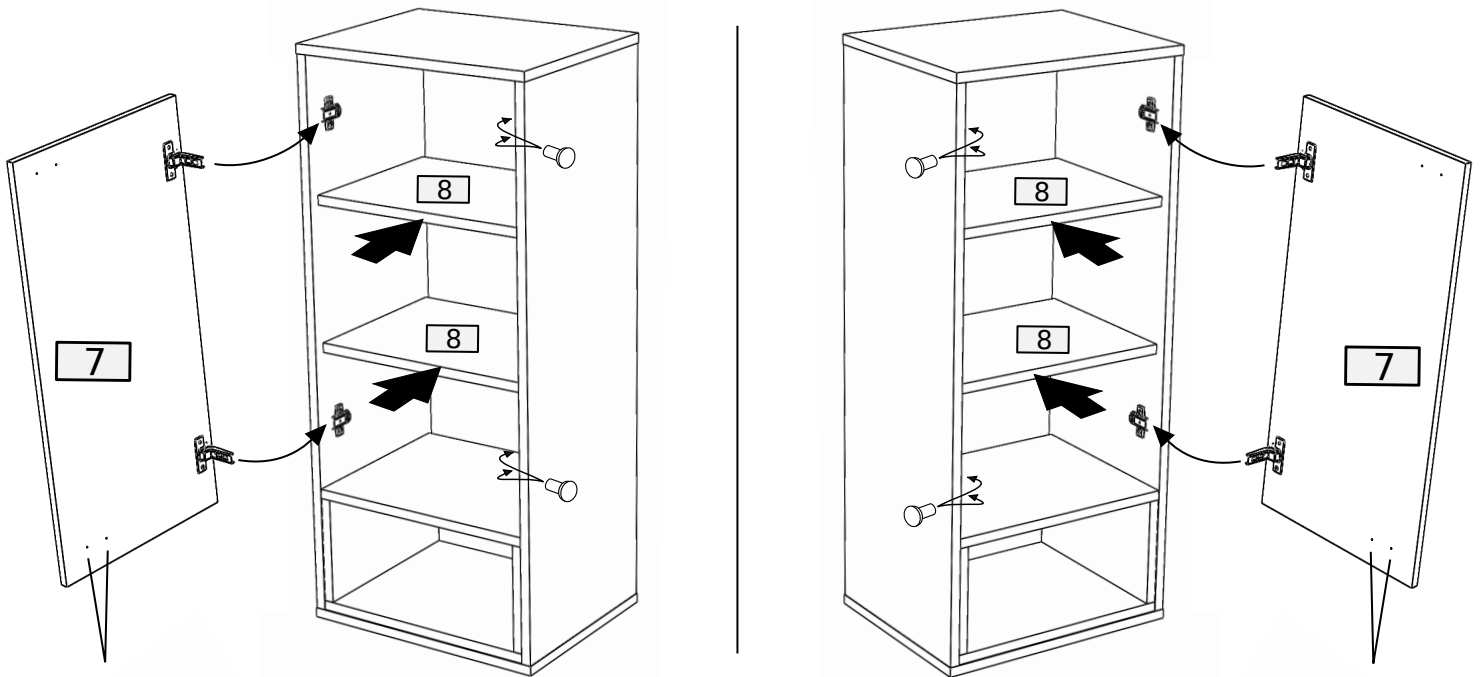
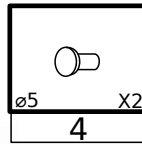

ø3.00 mm

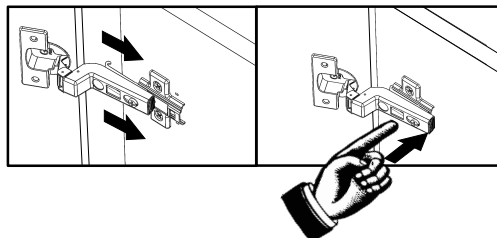

ø3.00 mm

12

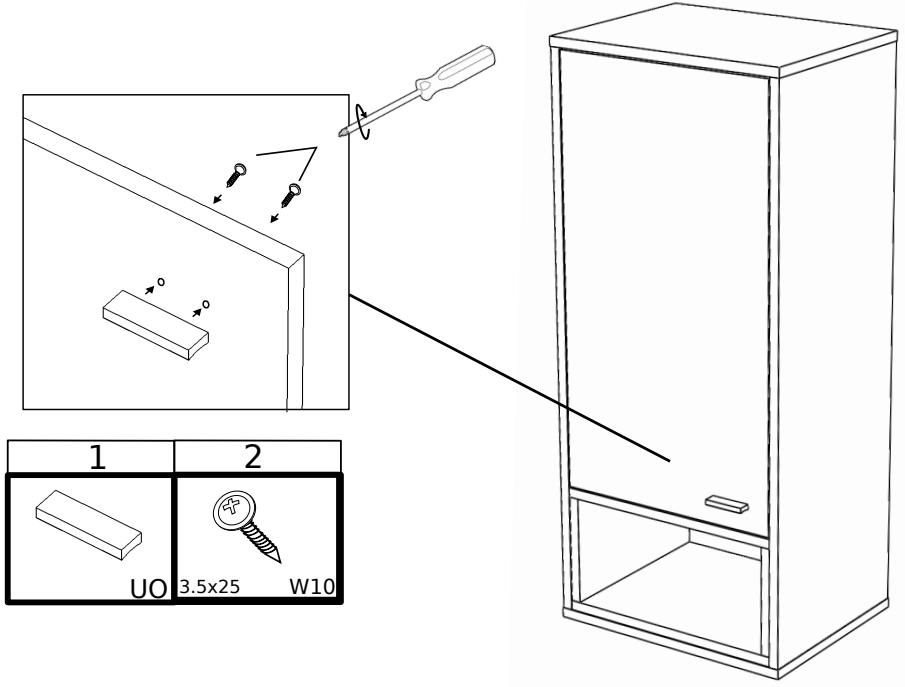

13

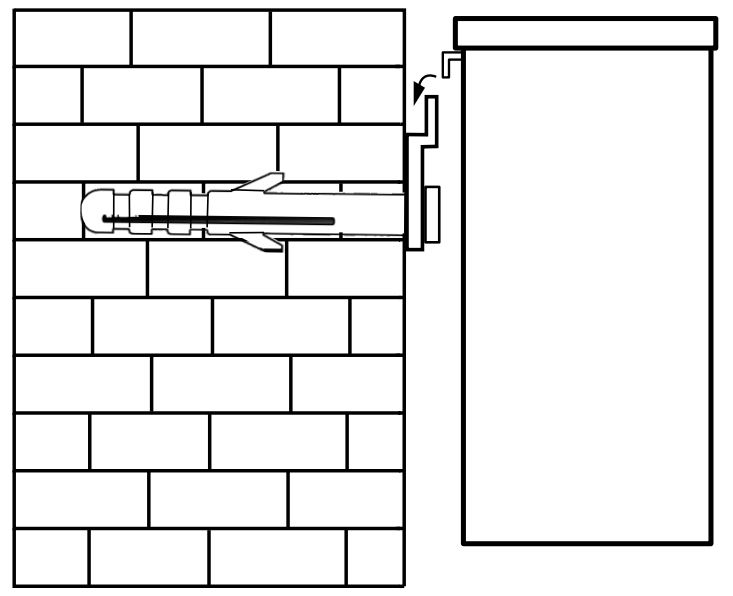
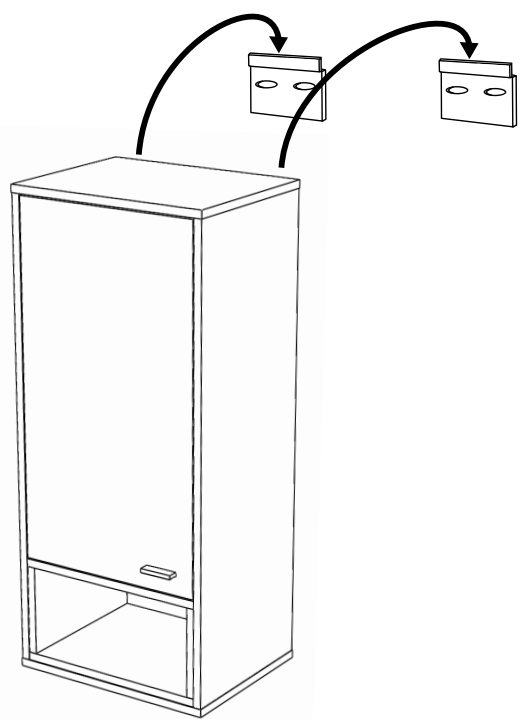
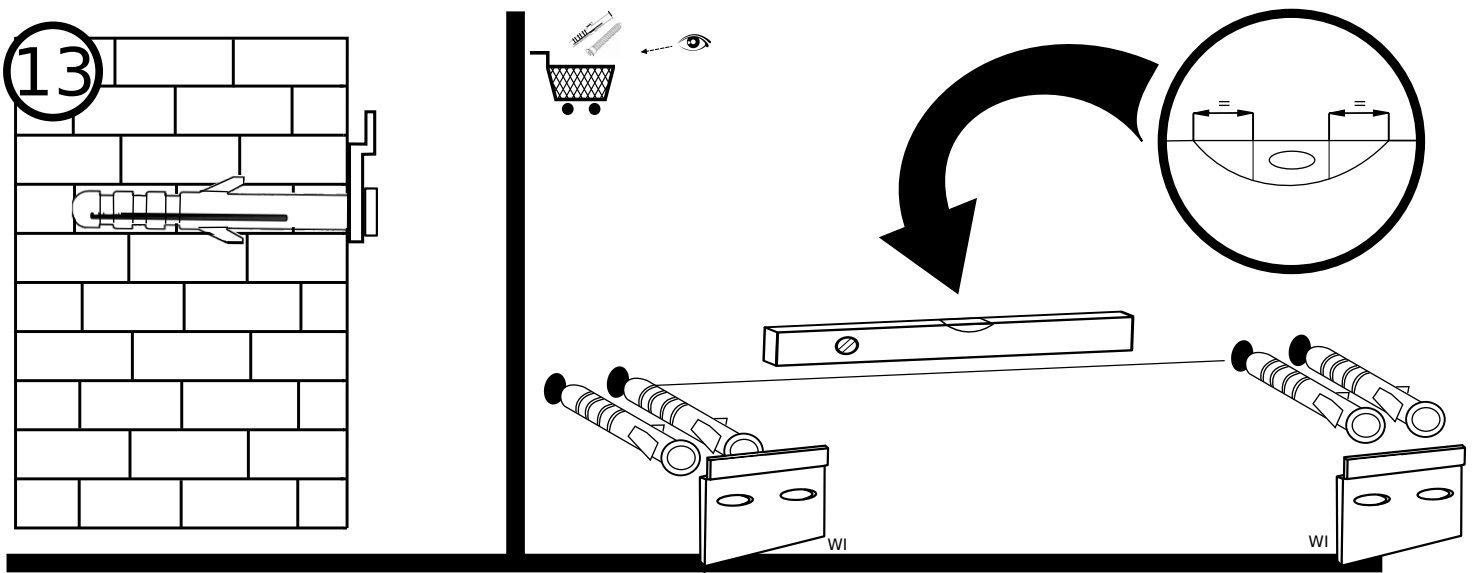

14

