

 O7 2	 P29 2	 E11 2	 A 12	 B 16	 C6 6	 D2 6	 E 6	 F1 4	 P14 8	 O 1
 †10x50mm	 †5.0x70mm	 †20	 †8x30mm	 6.4 x 50mm	 †15/18mm	 L=20mm	 60x40x20	 †4.0x25mm		

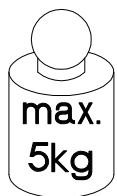

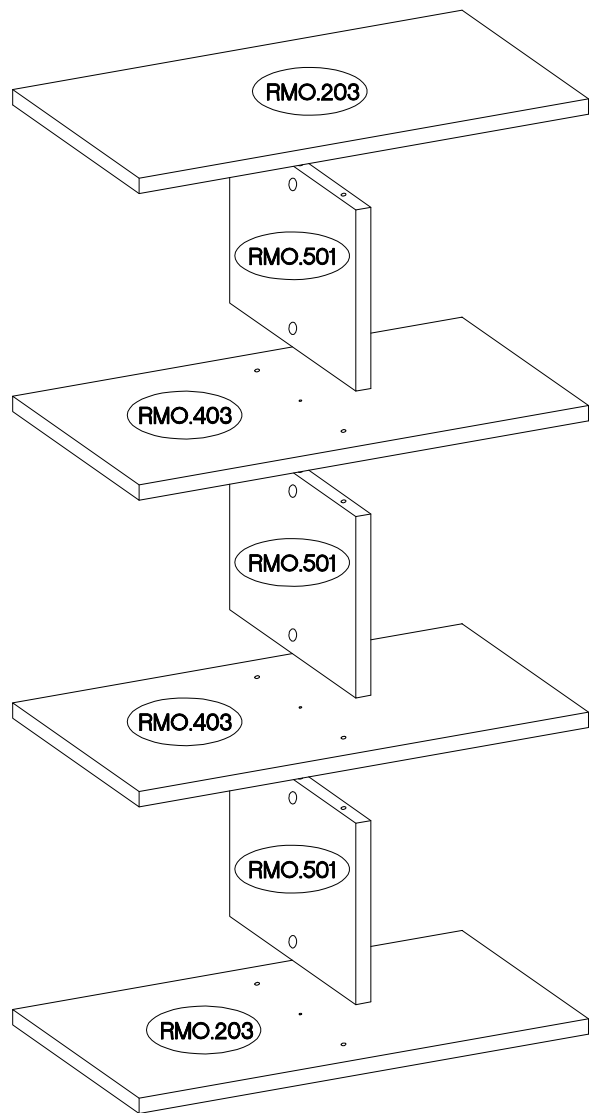

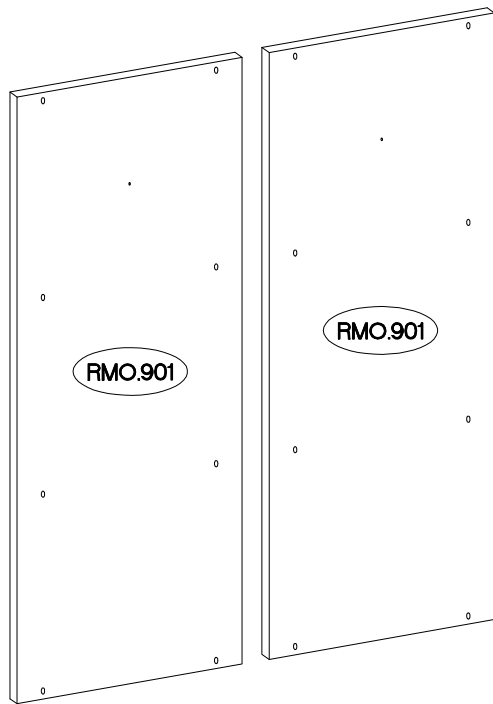

MSN.203

MSN.403

RMO.203 x 2	830x281x28
RMO.403 x 2	830x281x28
RMO.501 x 3	330x280x28
RMO.901 x 2	1104x416x16

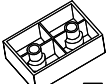
1

+8x30mm  A 12	+15/18mm  C6 6	L=20mm  D2 6	60x40x20  F1 4	+4.0x25mm  P14 8
--	---	---	---	---

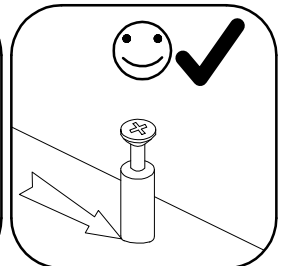
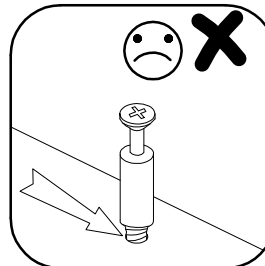
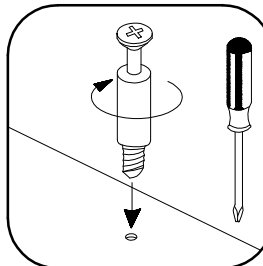
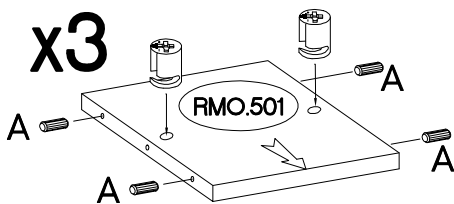
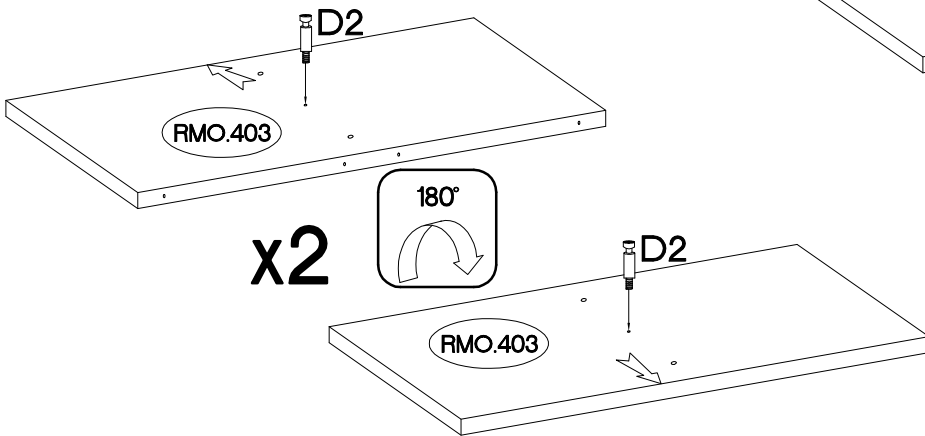
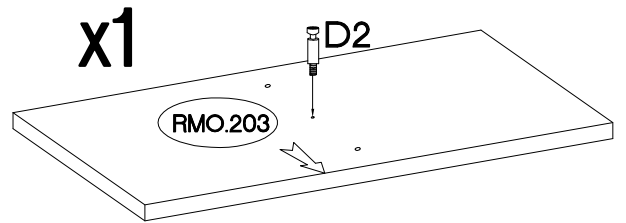
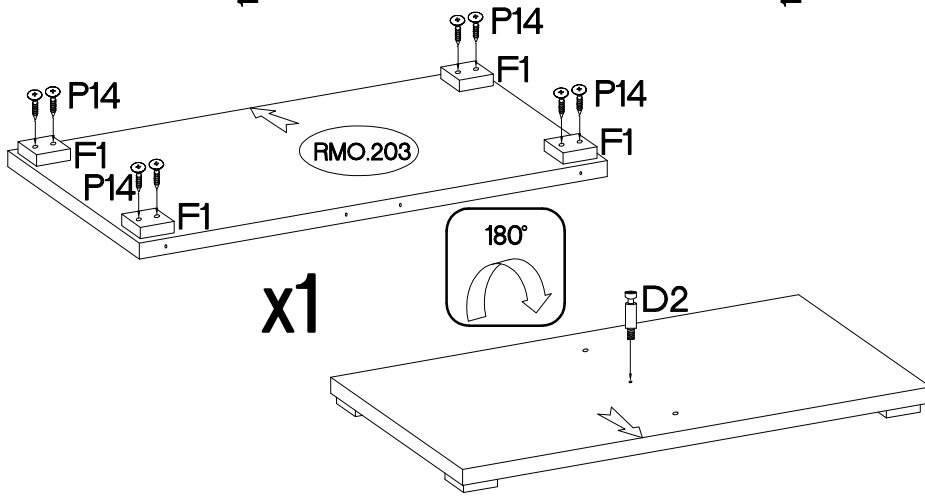
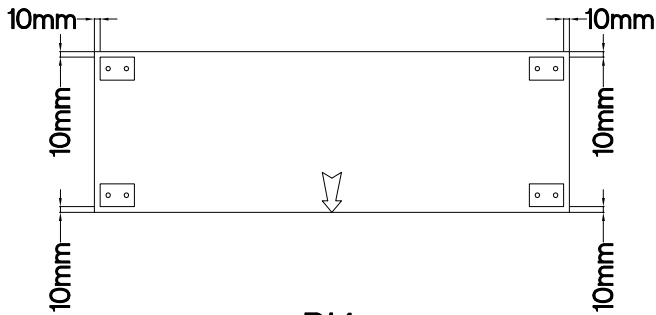
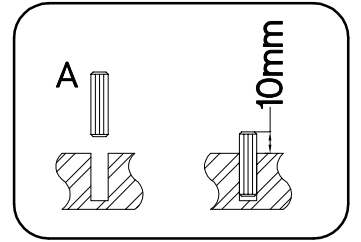
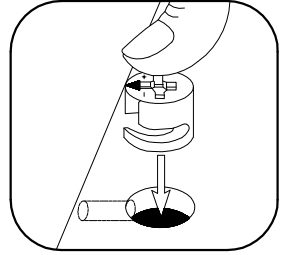
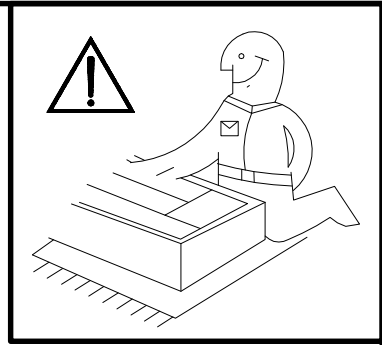

2

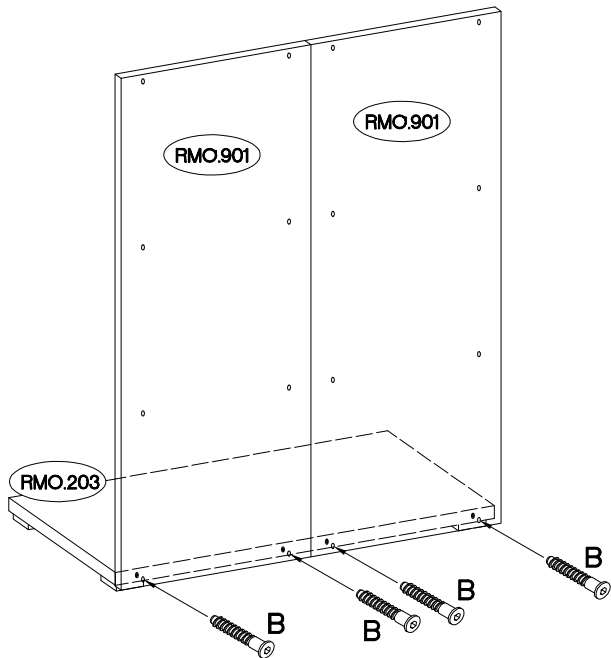
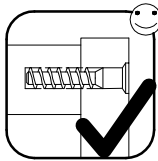
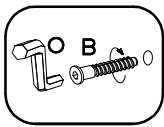
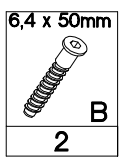

3

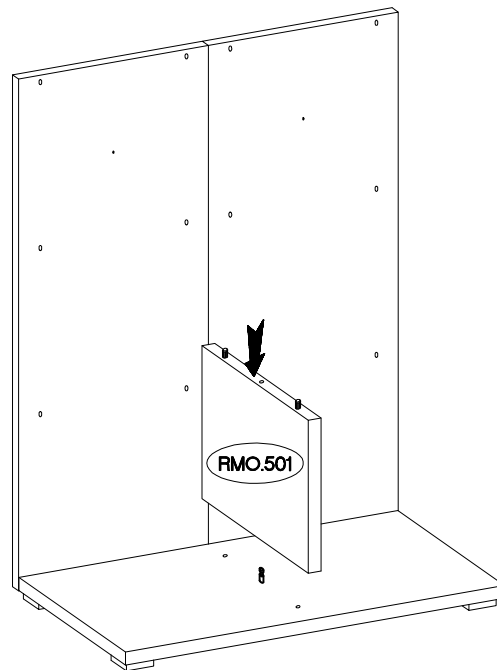
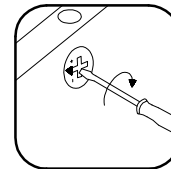
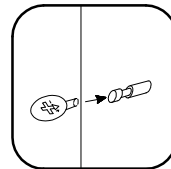

4

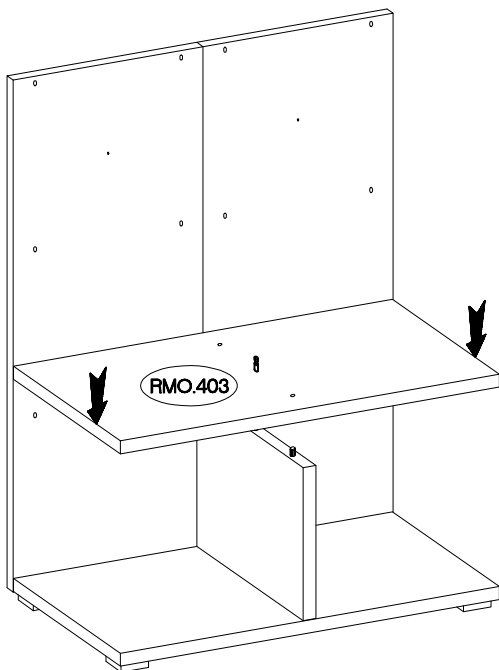
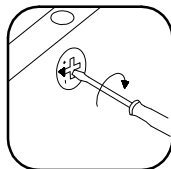
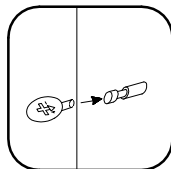

5

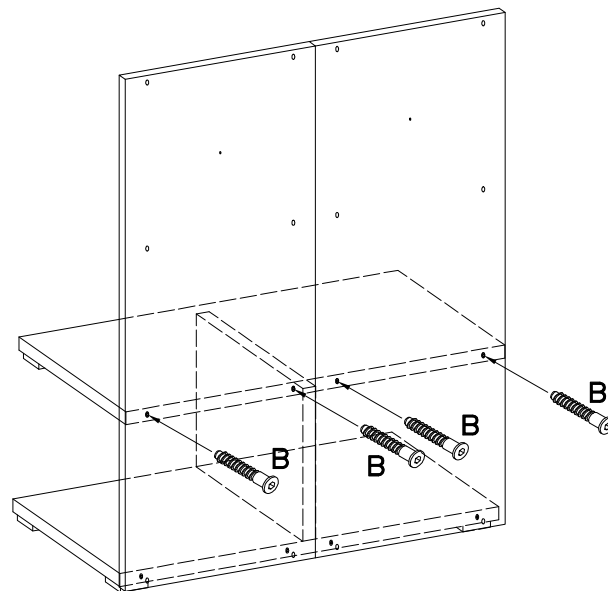
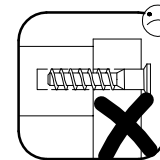
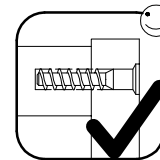
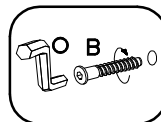
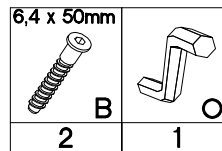

6

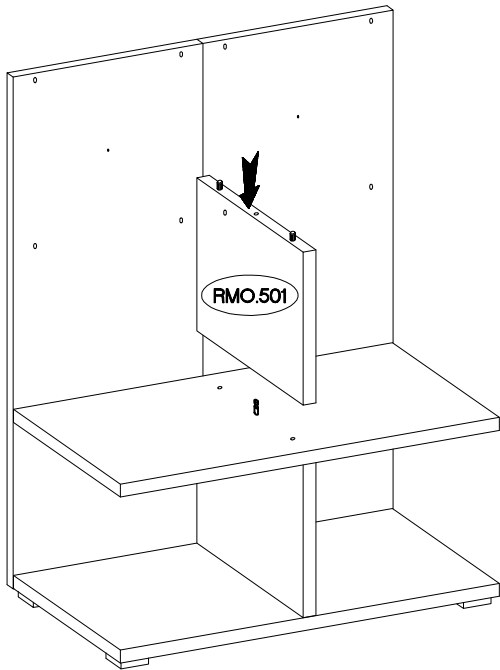
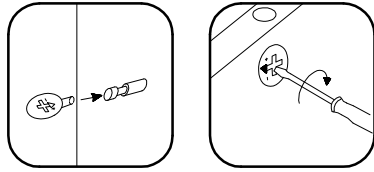

7

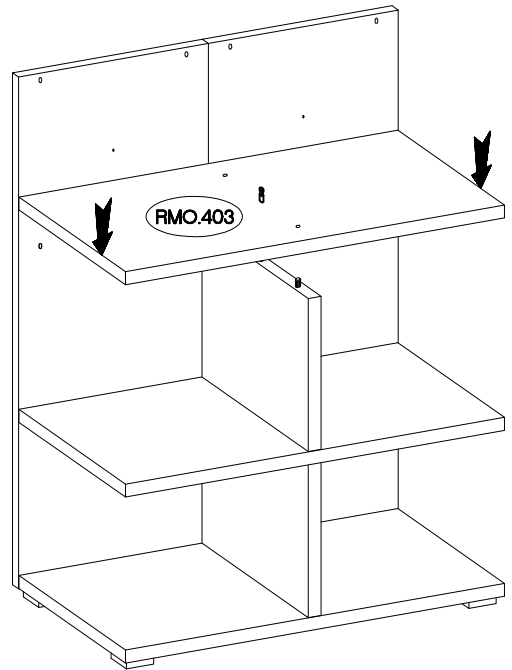
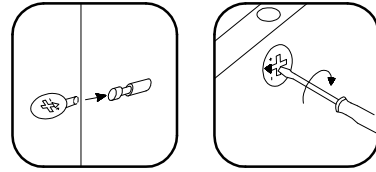

8

6,4 x 50mm

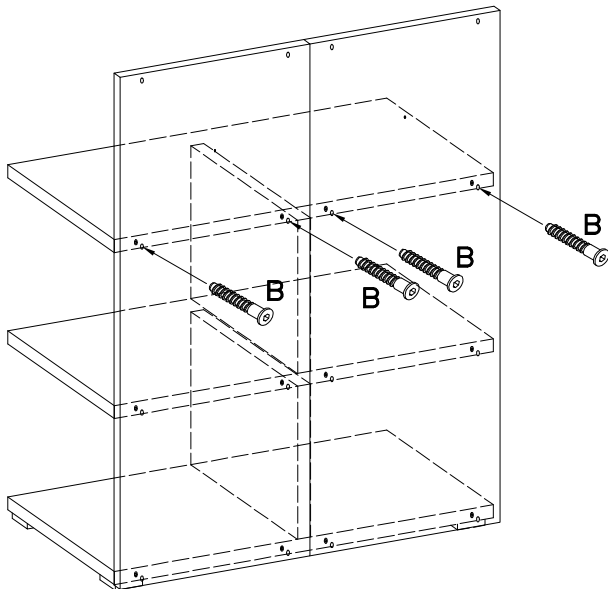
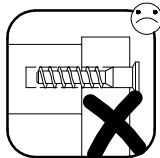
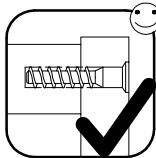
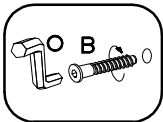
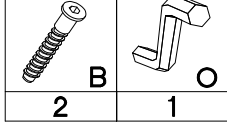

9

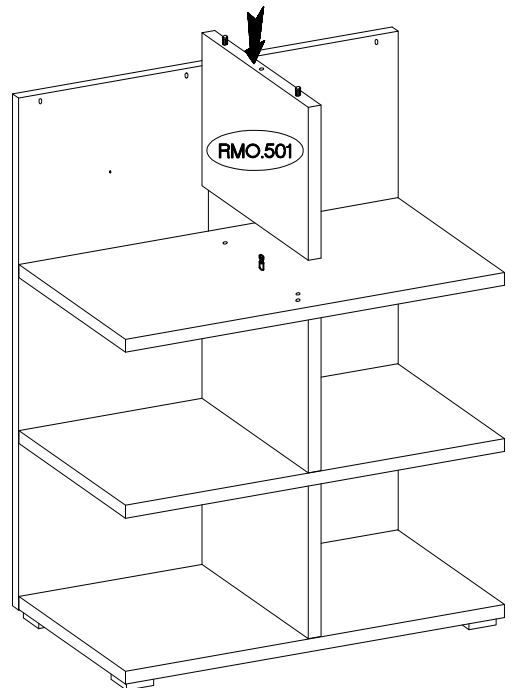
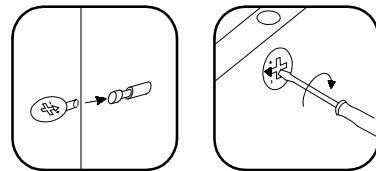

10

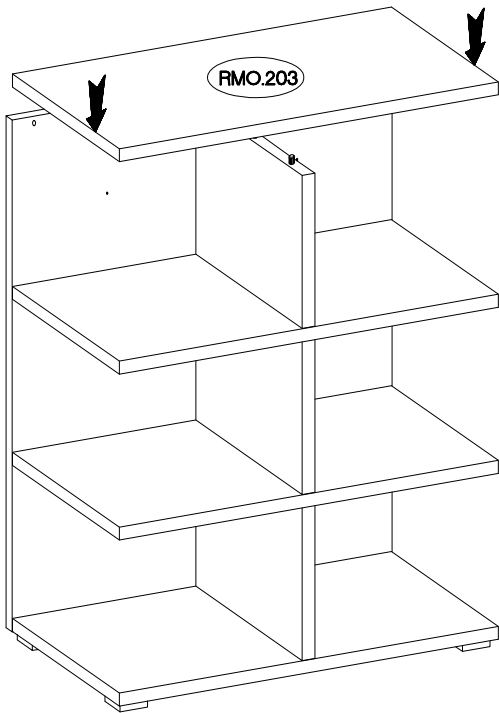
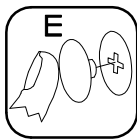
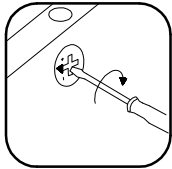
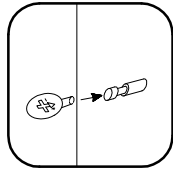
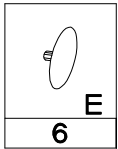

11

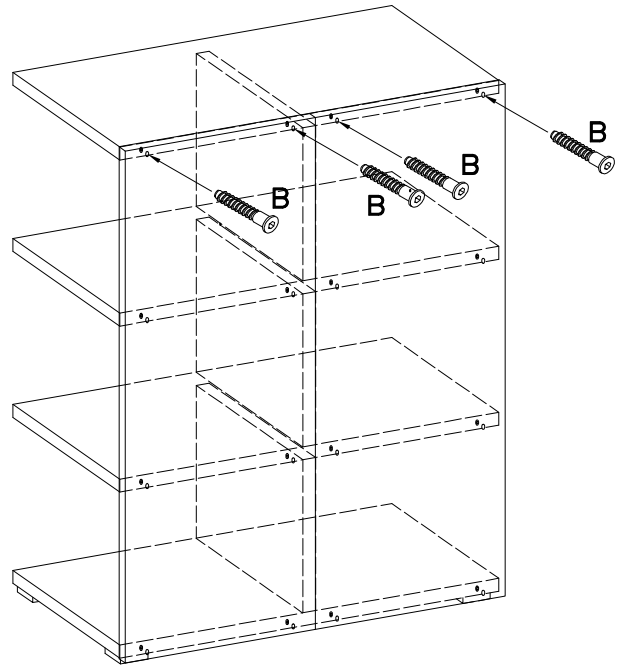
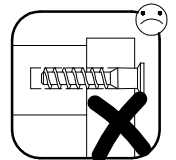
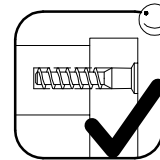
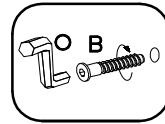
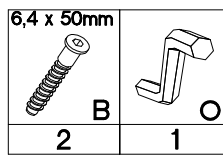

12

