











$\varnothing 8 \times 30 \text{mm}$	L=20mm	$\varnothing 5/12 \text{mm}$	$\varnothing 15 \times 5 \text{mm}$		0,05
					
A	D2	C	F4	E	O11
24	12	12	6	12	1

# 1.

 #8x30mm A	 L=20mm D2	 #15/12mm C	 0,05 O11
24	12	12	1

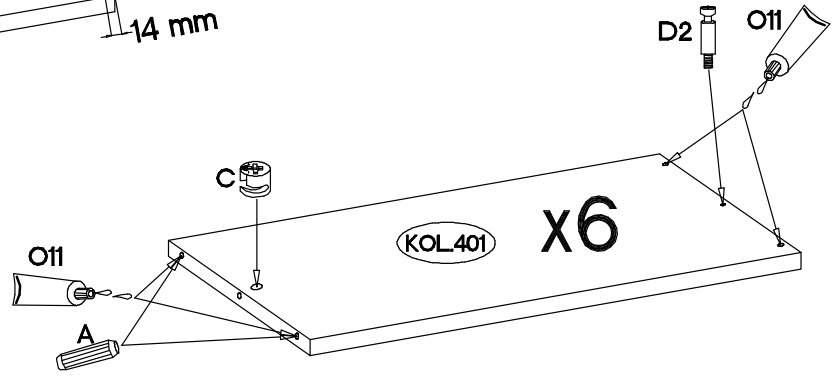
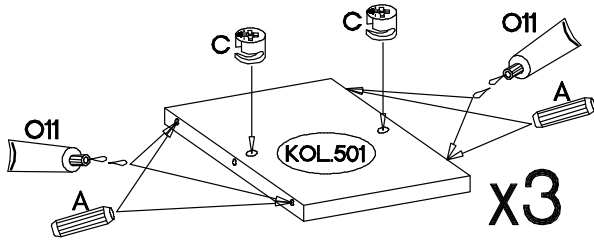
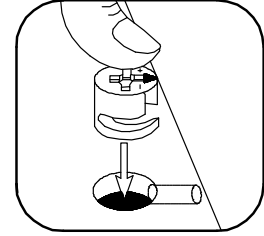
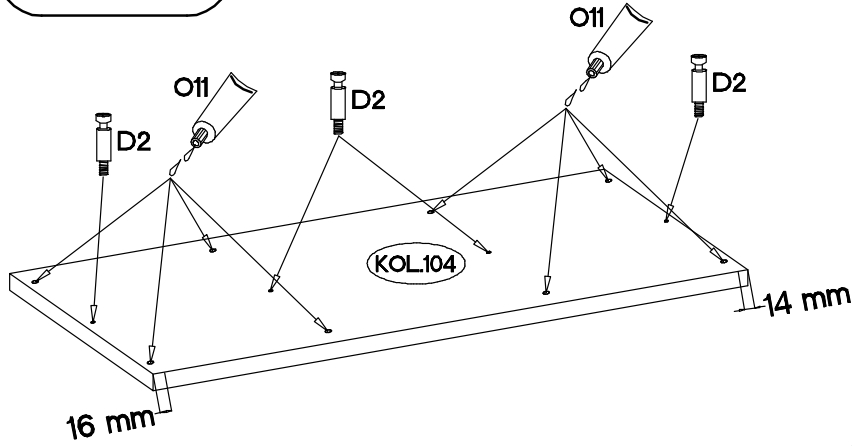
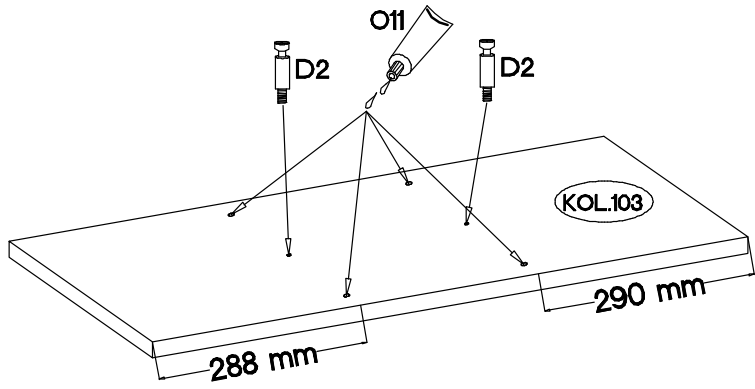
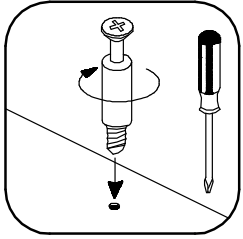

# 2.

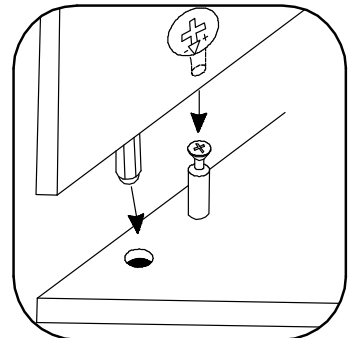
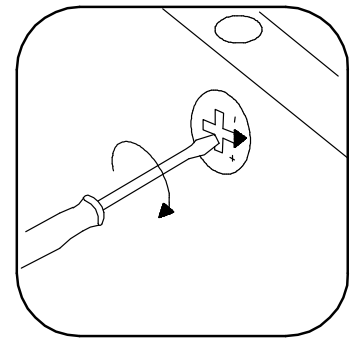
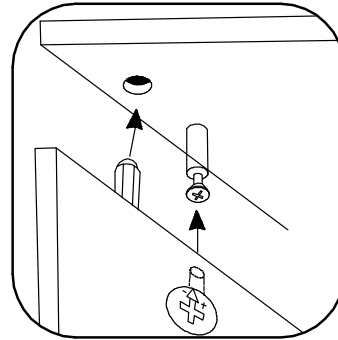
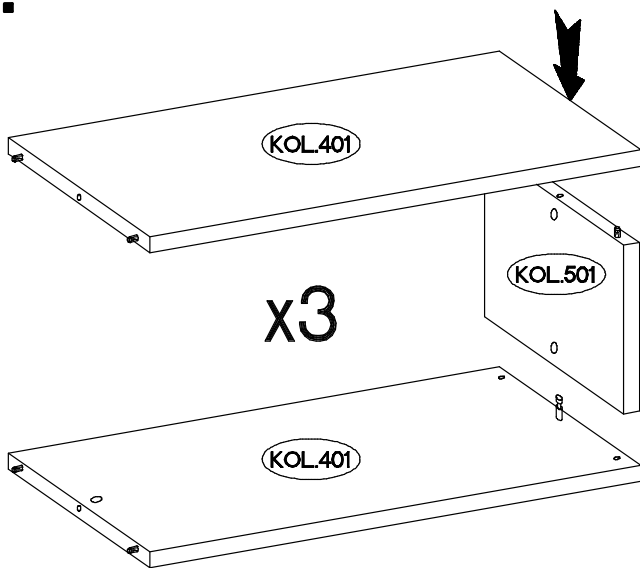

# 3.

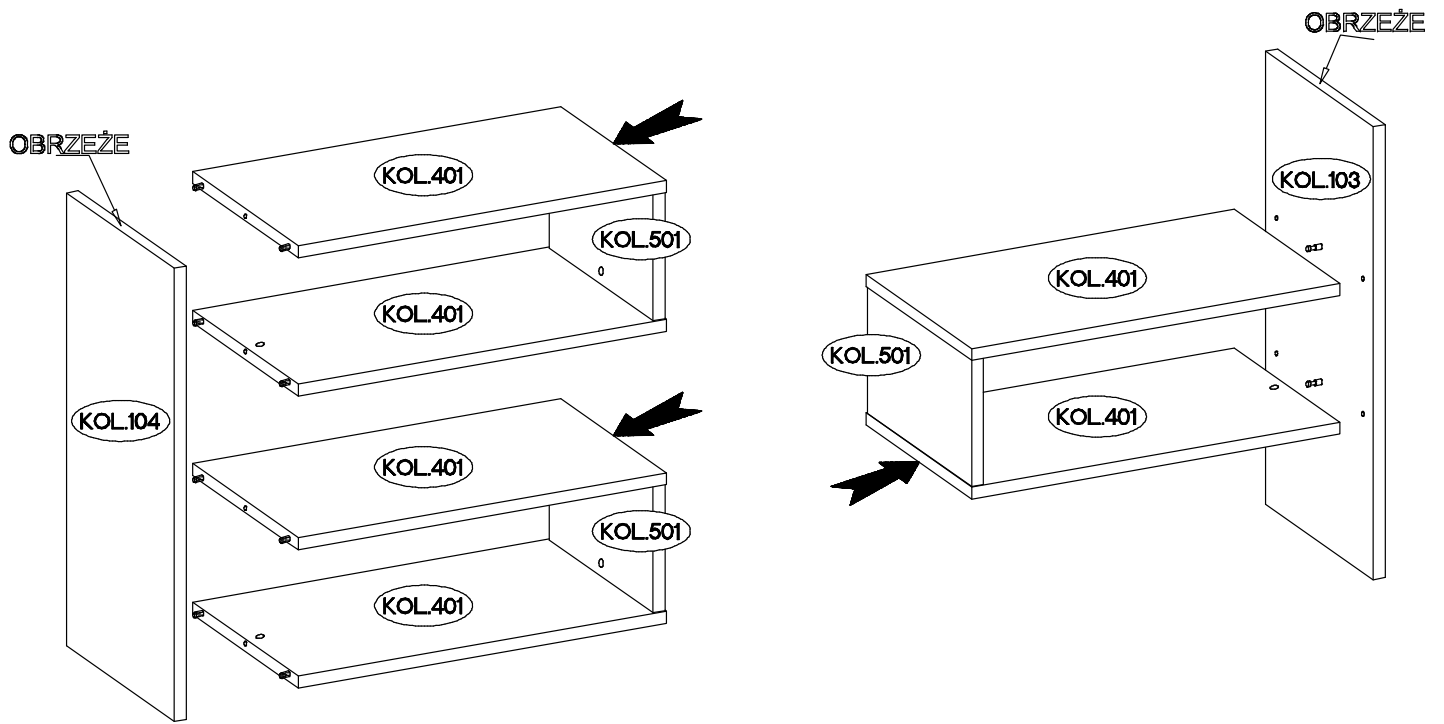

# 4.

